

DIVA



l'evoluzione del mobile cassa

check-out counters
design evolution

concept BY **INTRAC**
DESIGN & DISPLAY

DIVA

BY **INTRAC**
DESIGN & DISPLAY

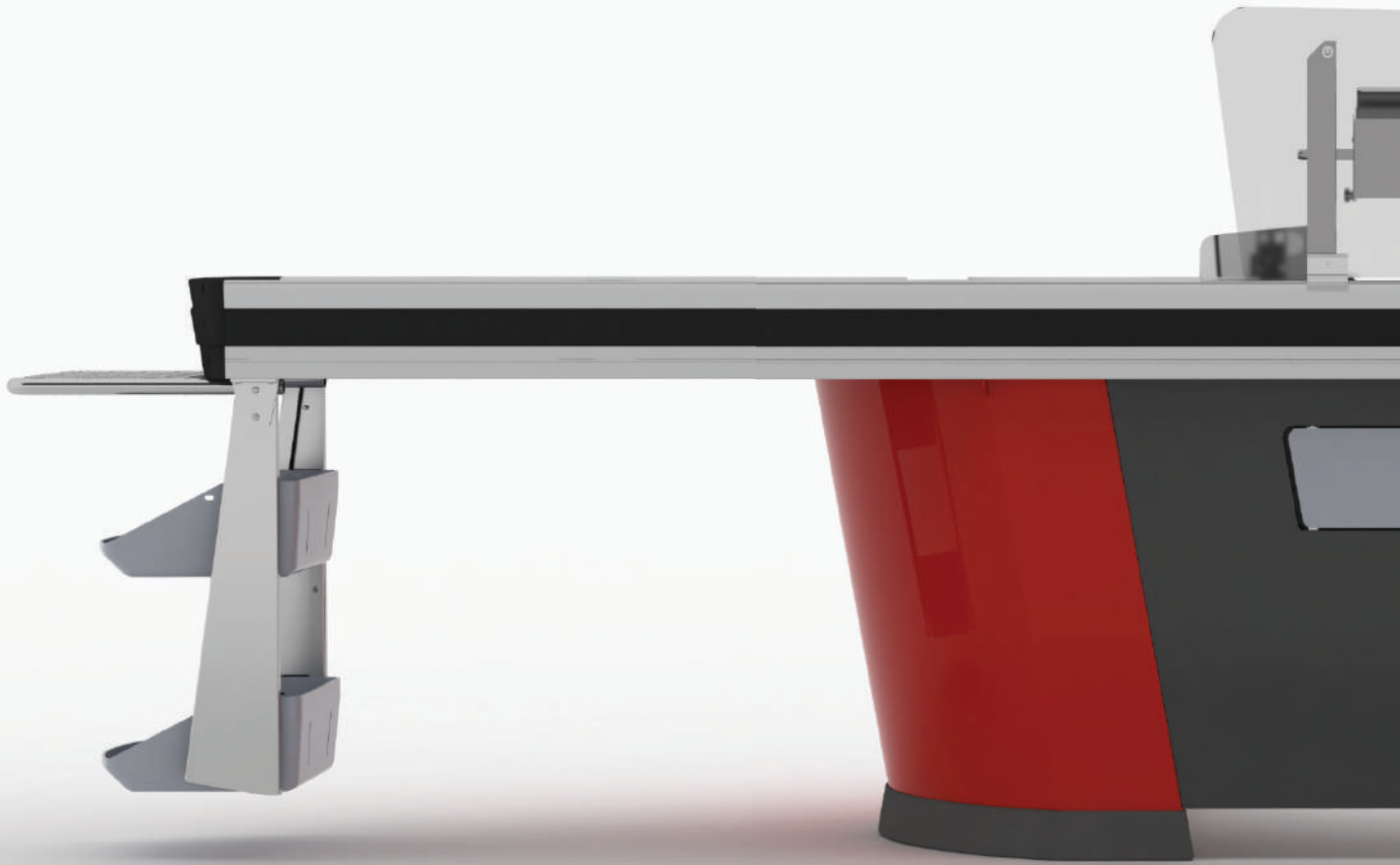

Chi siamo

INTRAC SPA ha la propria sede a Rovigo. Lo stabilimento di produzione, realizzato secondo i più moderni concetti produttivi, si espande su un'area di oltre 100.000 mq. di cui 40.000 coperti. Il core business dell'azienda sono le scaffalature ed i banchi cassa. INTRAC SPA elabora inoltre progetti d'arredamento per la piccola, media e grande distribuzione. La tecnologia utilizzata permette di realizzare in poco tempo una vasta gamma di prodotti di elevata qualità. Le scaffalature, colaminate o verniciate, sono prodotte con altissimi standard qualitativi, grazie a linee di produzione a controllo numerico e di verniciatura modernissime, unite a sofisticate macchine automatiche.

About us

INTRAC SPA is located in Rovigo. The production plant, built according to the most modern productive concepts, extends over an area of more than 100,000 sq.mt., with buildings occupying 40,000 sq.mt. The company's main line of business is shelving and check-out modules. INTRAC SPA also develops projects for the furnishing of small, medium and large grocery stores. The technology used enables the company to realise a vast range of high-quality products in a short space of time. Co-laminated or painted shelving is produced to very high quality standards, thanks to production lines with numerical control and modern painting systems, together with sophisticated automatic machines.

Wir über uns

INTRAC SPA hat ihren Firmensitz in Rovigo. Das nach den modernsten Produktionskonzepten realisierte Werk befindet sich auf einem Werksgelände über 100.000 m² und davon sind 40.000 m² überdacht. Die Hauptprodukte des Unternehmens sind Regale und Kassenmöbel. INTRAC SPA erarbeitet ferner Einrichtungspläne für den kleinen, mittleren und großen Vertrieb. Die eingesetzte Technologie ermöglicht es, in kürzester Zeit eine große Produktreihe höchster Qualität zu produzieren. Dank der Produktionslinien mit numerischer Kontrolle und modernsten Lackierungssystemen sowie der automatischen High-Tech-Maschinen werden die kunststoffbeschichteten bzw. lackierten Regale mit höchstem qualitativen Standard hergestellt.



Take **Intrac** into your **service**
We support your ideas

4



Qui sommes-nous

INTRAC SPA a son propre siège à Rovigo. Son établissement de production, conçue selon les concepts de production les plus modernes, s'étend sur une surface de plus de 100 000 m² dont 40 000 couverts. Les rayonnages et les meubles caisse de sortie sont le cœur du business de l'entreprise. En outre, INTRAC SPA élabore des projets d'ameublement pour la petite, la moyenne et la grande distribution. La technologie utilisée permet de réaliser en peu de temps une gamme très large de produits de haute qualité. Les rayonnages, co-laminés ou laqués, sont produits selon des standards de très haute qualité grâce à des lignes de production à commande numérique et des lignes de vernissage ultramodernes avec des machines automatiques très sophistiquées.

Quiénes somos

INTRAC SPA tiene su sede en Rovigo. El establecimiento de producción, realizado según los más modernos conceptos productivos, se expande en un área de más de 100.000 m² de los cuales 40.000 cubiertos. La actividad principal de la empresa son las estanterías y los muebles de caja. Además, INTRAC SPA elabora proyectos de amueblado para la pequeña, media y grande distribución. La tecnología utilizada permite realizar en poco tiempo una amplia gama de productos de calidad elevada. Las estanterías, co-laminada o pintadas, se producen con un estándar de calidad elevado gracias a líneas de producción con control numérico y de pintura modernísimas, unidas a sofisticadas máquinas automáticas.

О компании

Головное предприятие компании INTRAC SPA расположено в г. Ровиго. Производственные цеха, оснащенные самым современным оборудованием, занимают площадь более 100 000 кв.м. (из них 40 000 кв.м под крытые помещения). Специализация компании – производство стеллажного оборудования и кассовых боксов. Кроме того, специалисты компании разрабатывают проекты оснащения сетевых объектов различной площади. Применяемые технологии позволяют в кратчайшие сроки произвести широкий модельный ряд оборудования высокого качества. Стеллажное оборудование (пластифицированное и окрашенное) производится в соответствии с самыми высокими мировыми стандартами на автоматизированных конвейерных линиях с ЧПУ. Для окраски оборудования используются современные покрасочные камеры с автоматическим управлением.



Le attività interne sono programmate e coordinate seguendo un concetto di estrema flessibilità; l'organizzazione è stata infatti pensata per rispondere nel modo più rapido alla domanda proveniente dal mercato.

Les activités intérieures sont programmées et coordonnées en suivant un concept de souplesse extrême. L'organisation a en effet été conçue pour répondre le plus rapidement possible à la demande provenant du marché.



The internal activities are planned and coordinated according to a concept of extreme flexibility: the organization has in fact been conceived in order to supply the most rapid response to market demands.

Las actividades internas están programadas y coordinadas siguiendo un concepto de máxima flexibilidad; por eso, la organización se ha pensado para responder rápidamente a las exigencias del mercado.



Die betriebsinternen Tätigkeiten werden nach einem extrem flexiblen Konzept programmiert und koordiniert; die Organisation dient vor allem dazu, auf rasche Weise den Nachfragen des Marktes nachzukommen.

Гибкая административно-производственная деятельность компании построена и управляется таким образом, чтобы как можно более оперативно отвечать на требования рынка.

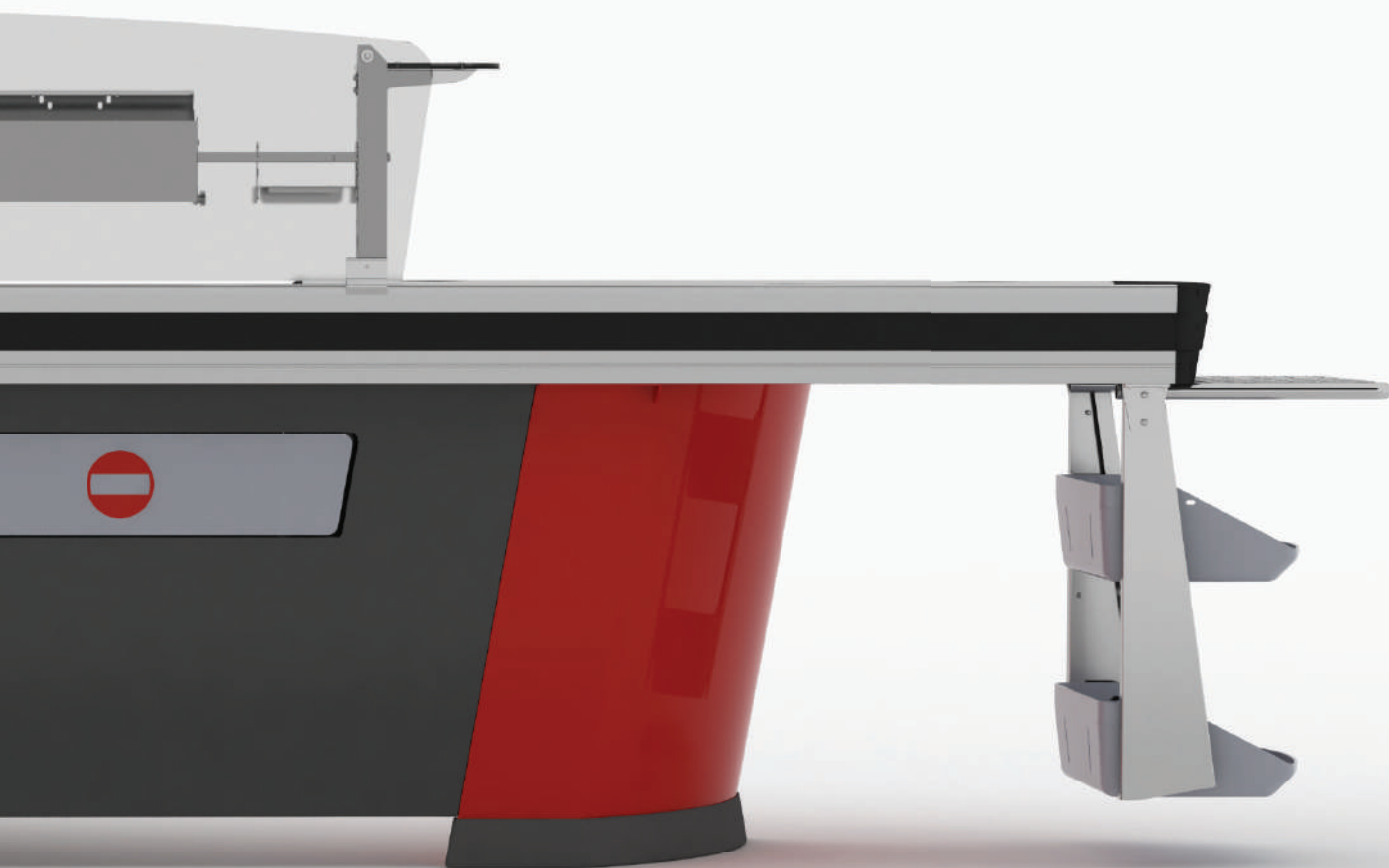

ELEGANZA_{nel} DNA
ELEGANCE_{in our} DNA



la sintesi >

design e minimalismo per una soluzione versatile d'arredo contemporaneo

design and minimalism for modern design solutions



DIVA è la nuova linea di banchi cassa proposta da INTRAC, sintesi di ergonomia e funzionalità. Una Linea estetica inscritta nelle tendenze attuali, caratterizzata da geometrie semplici, completata da un'ampia scelta di accessori che le consentono di adattarsi a qualsiasi evenienza. Una gamma di modelli adatta ad ogni superficie di vendita, in grado di soddisfare qualsiasi esigenza di arredamento.

DIVA is a new line of check-out counters by INTRAC, synthesis of ergonomics and functionality. An aesthetic line formed by the last iconic trends, simple geometric character, completed by a wide proposal of accessories which let it be able to satisfy any occurrence. A complete range of models allowing it to fulfill any needs of shop design and layout.

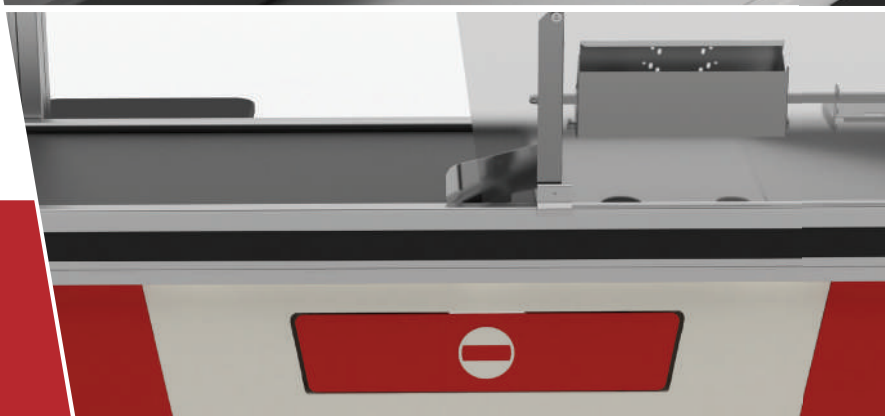
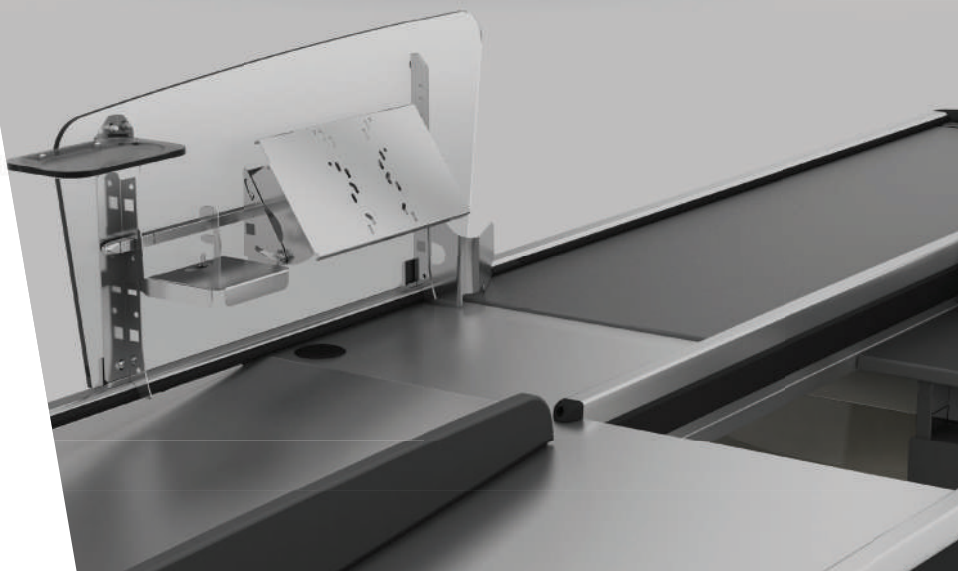
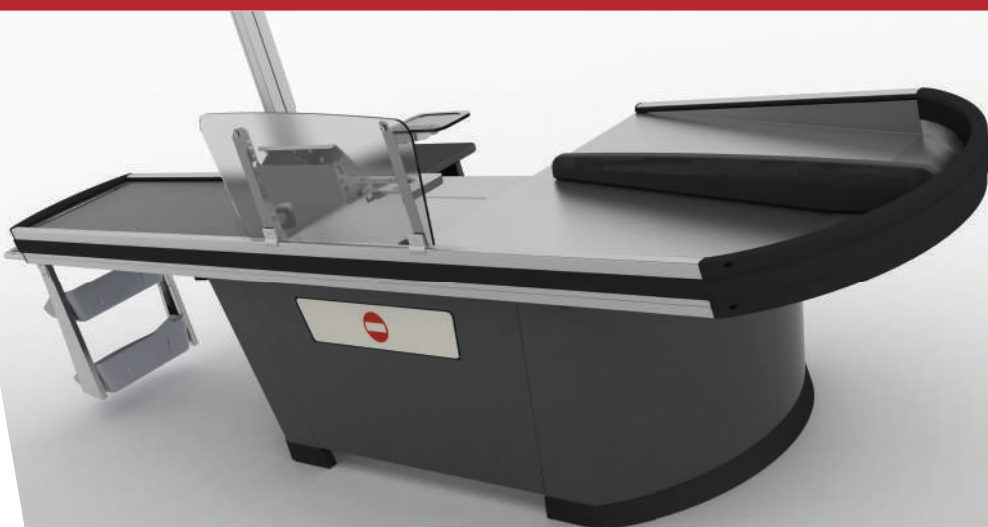

ERGONOMIA

ERGONOMICS

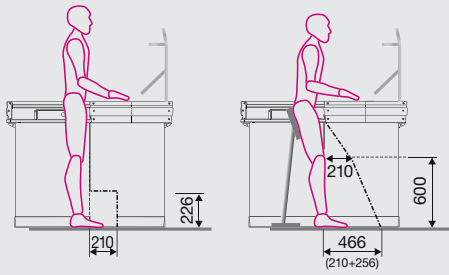

Sezione vano gambe per postura in piedi con e senza ausilio.

Section view of the legs compartment; standing posture with or without aid.

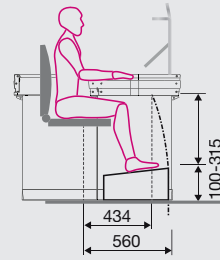

Sezione vano gambe per posizione seduta.

Section view of the legs compartment: sitting posture.

zone di lavoro,
campo visivo,
versioni e altezza

work areas, field of vision,
versions and height

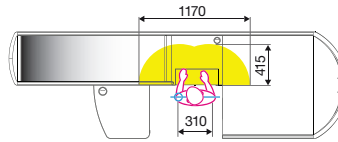
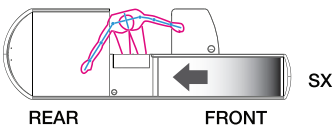
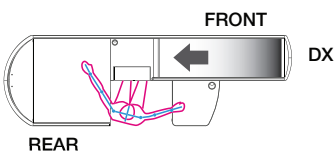
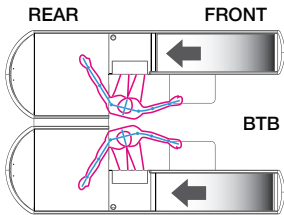

Spazio di prensione massima.
Maximum grasping area.

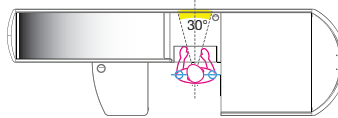

Campo visivo preferenziale in orizzontale.
Preferential horizontal field of vision.

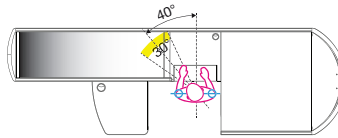

Campo visivo massima orizzontale.
Maximum horizontal field of vision.

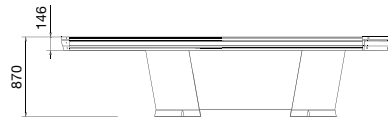

Altezza (H)
Height (H)



CARATTERISTICHE TECNICHE

TECHNICAL FEATURES



Motore ad alta potenza di trascinamento con raffreddamento ad olio. Nastro in PVC a doppia tela con possibilità di personalizzazione con logo vulcanizzato

Motor with high belt drive power and oil cooling. PVC double conveyor belt can be personalized with a vulcanized logo

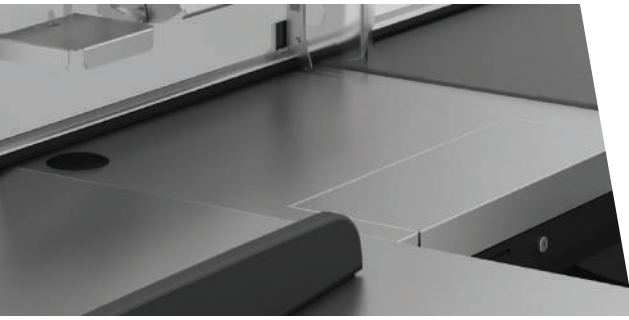

Piano di lavoro/scanner in acciaio inox rigidizzato (cassetto elettronico porta-monete opzionale)

Central Scanner module in stiffened steel (optional cash-drawer)



Quadro elettronico di comando Touch alloggiato in posizione ergonomica

Electronic Touch control panel ergonomically positioned

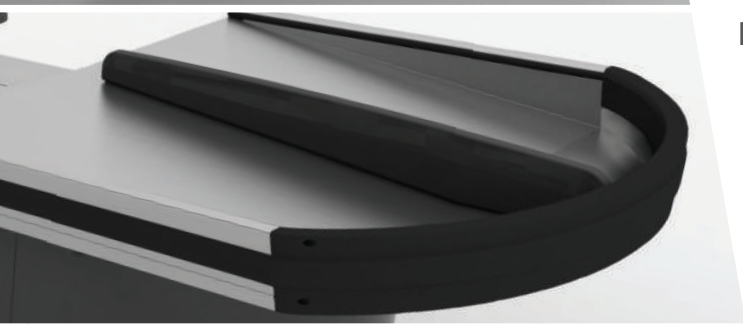

Modulo vasca posteriore inclinato in acciaio inox rigidizzato realizzato in uno stampo unico, completo di frontale e paracolpi merce arrotondato in poliuretano morbido antiurto, autoestinguente e antifumo, di colore nero

Rear module with inclined basin in stiffened stainless steel and completed with rounded bumper profile made of soft shock-proof, self-extinguishing and anti-smoke, black polyurethane



Fotocellula a doppio sensore per la sicurezza dell'operatore

Double photocell sensors for operator safety



Cancelletto integrato ed estensibile opzionale

Integrated and extensible trolley blocking device (optional)



BY INTRAC
DESIGN & DISPLAY

descrizione tecnica technical description

Upper supporting structure in anodized aluminum and steel painted in Ral 9005, completed with front and rear bumpers in soft, shock-proof polyurethane (UV-resistant and anti-smoke), lateral and rear black rigid PVC bumper profiles.

Central module made of stiffened AISI 304 stainless steel, arranged with closed panel with dimensions 350mm up to 550mm. Dimensions 350mm arranged to house only a scanner; dimensions 550mm arranged to house a scanner and a cash drawer.

Rear module with inclined basin in stiffened stainless steel, reinforced by wooden panel.

Lower supporting structure in steel, protected on the floor by black or grey plastic baseboards.

Front and lateral trims in steel sections painted in color to be defined, fixing to the floor inside the legs.

Cash-register shelf in grey, scratch-proof melamine wood, protected by an external black ABS edge.

Electronic Touch control panel ergonomically positioned.

Internal wiring predisposition for the POS system.

The anti-static conveyor belt in polyester double cloth is driven by a high power motor drum, soft start available as an option. Double photocell sensors for a higher sensibility and safety.

Trolley blocking device available as integrated, integrated extensible into the lateral trim or external.

Wide range of accessories able to satisfy every needs.

Struttura superiore in alluminio anodizzato e acciaio verniciato Ral 9005, completa di frontone anteriore e posteriore in poliuretano morbido antiurto (resistente UV e antifumo), protetta lateralmente e posteriormente da un profilo batticarello in PVC rigido nero.

Modulo centrale in acciaio AISI 304 rigidizzato, configurazione base chiusa nelle dimensioni 350-550mm. Dimensioni 350mm con predisposizione solo scanner; dimensioni 550mm con predisposizione alloggiamento scanner e cassetto porta monete.

Modulo vasca inclinata posteriore realizzata in un pezzo unico stampato in acciaio AISI 304 rigidizzato con bordi arrotondati.

Struttura inferiore portante in acciaio di forma arrotondata ed inclinata verniciata di base in colore standard protetta a pavimento da zoccoli in plastica ABS nera o grigia, carenatura frontale verniciata con colore da definire nella gamma colori, fissaggio mobile a pavimento tramite la predisposizione nelle gambe.

Piano registratore in legno nobilitato antigraffio nero con profilo perimetrale in ABS.

Quadro elettronico di comando di tipo Touch alloggiato in posizione ergonomica.

Predisposizione per passaggio cavi del POS.

Nastro in PVC antistatico con doppia tela nera in PVC/Poliestere mosso da un motore ad alta potenza di trascinamento con funzione partenza graduale (opzionale). Fotocellule a doppio sensore per una maggiore sensibilità e sicurezza.

Cancello chiusura corridoio fornibile in opzione integrato, integrato estensibile nella carena longitudinale o esterno.

Gamma di accessori completa e funzionale.

colori standard standard colours

RAL9006	RAL1016	RAL5014
RAL9010	RAL2004	RAL6002
RAL9005	RAL3003	RAL6017
RAL3020	RAL3005	RAL6019
RAL1018	RAL4003	RAL7011
RAL5010	RAL5002	RAL7016

proposte colori
color proposals

DIVA

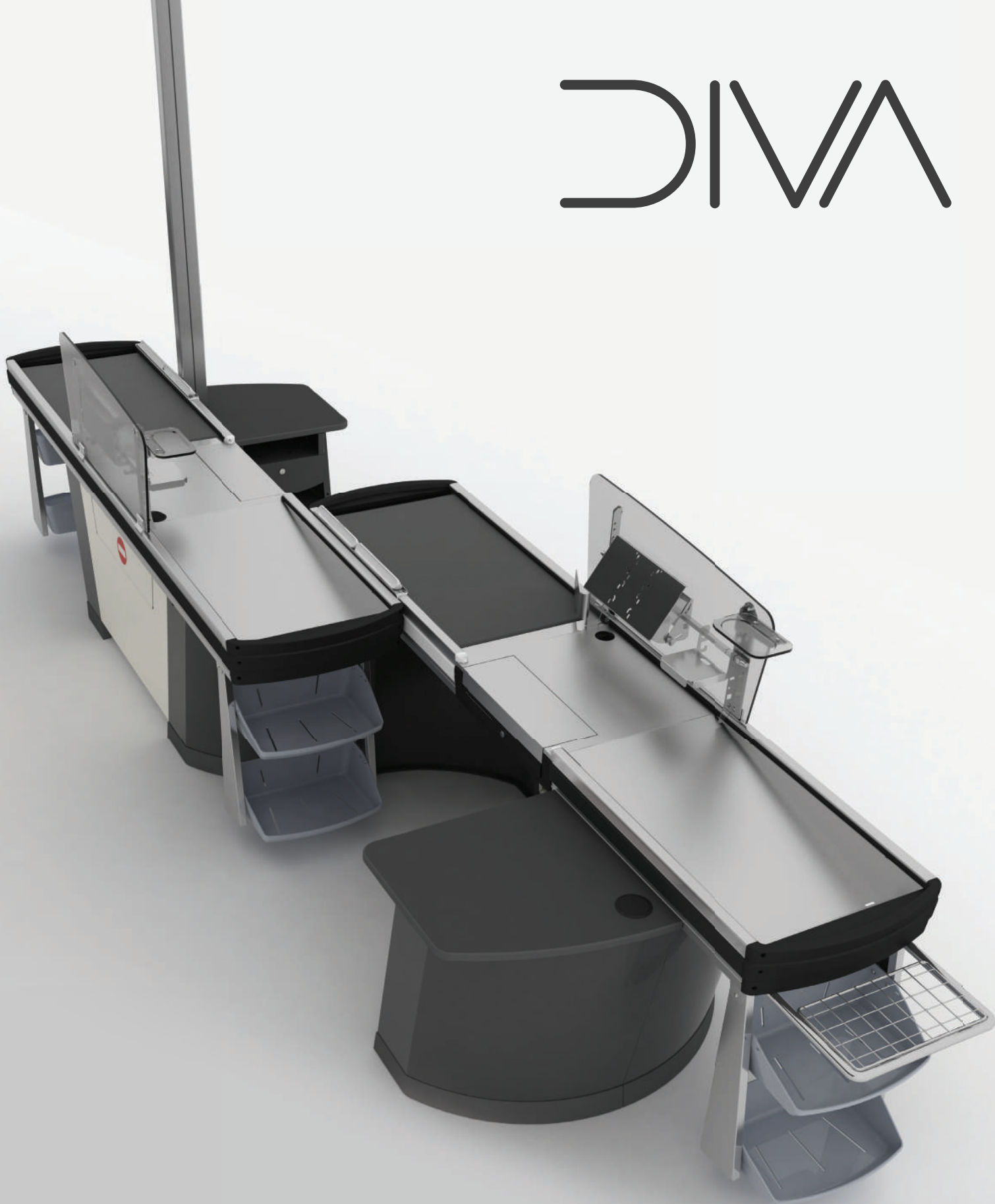

ACCESSORI
ACCESSORIES



DIVA



Fronte operatore

Front Cashier

- 1A. Protezione scanner Semi-ELIPSE
Semi-ELIPSE scanner protection set
- 1B. Protezione scanner Semi-ELIPSE + film opaco
Semi-ELIPSE scanner protection set with opaque set
- 1C. Protezione scanner "10G" - "10G" Scanner protection set
- 1D. Protezione scanner 9800 - 9800 Scanner protection set
- 2A. Attacco tastiera - Porta oggetti per 1A
Connection for keyboard, object holder per 1A
- 2B. Attacco tastiera - Porta oggetti per 1B
Connection for keyboard, object holder per 1B
- 2C. Attacco tastiera - Porta oggetti per 1C
Connection for keyboard, object holder per 1C
- 2D. Attacco tastiera - Porta oggetti per 1D
Connection for keyboard, object holder per 1D
- 3. Supporto Porta Oggetti - Object Holder
- 4A. Porta tastiera L350 - Keyboard support L350
- 4B. Porta touch-screen L350 - Touch-screen support L350
- 5. Lente grandangolare - Wide-angle lens
- 6. Supporto rotante con braccio per PIN-PAD
Rotating support for PIN-PAD with arm
- 7. Supporto rotante per PIN-PAD
Rotating support for PIN-PAD
- 8. Gancio standard per pistola scanner
Scanner holding standard hook
- 9. Cassetto rendiresto 12/24/36V completo di inserto cassetto rendiresto
Cash drawer 12/24/36V with cash insert unit
- 10. Inserto cassetto rendiresto - Cash insert unit
- 11. Deviamerze - Grocery deviator
- 12A. Tasca rendiresto in plexi per 1A (compreso in 1A)
Plexi money tray for 1A (included in 1A accessory)
- 12B. Tasca rendiresto in plexi per 1B (compreso in 1B)
Plexi money tray for 1B (included in 1B accessory)
- 12C. Tasca rendiresto in plexi per 1C
Plexi money tray for 1C
- 12D. Tasca rendiresto in plexi per 1D (compreso in 1D)
Plexi money tray for 1D (included in 1D accessory)

ACCESSORI

ACCESSORIES

12

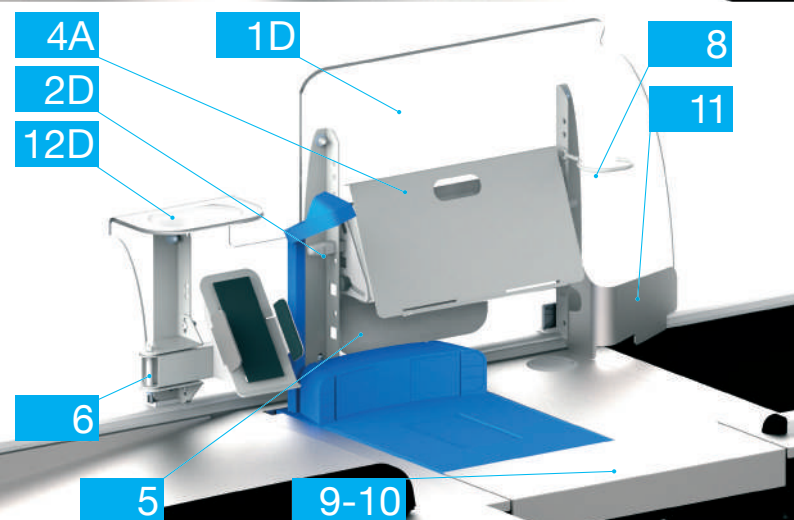
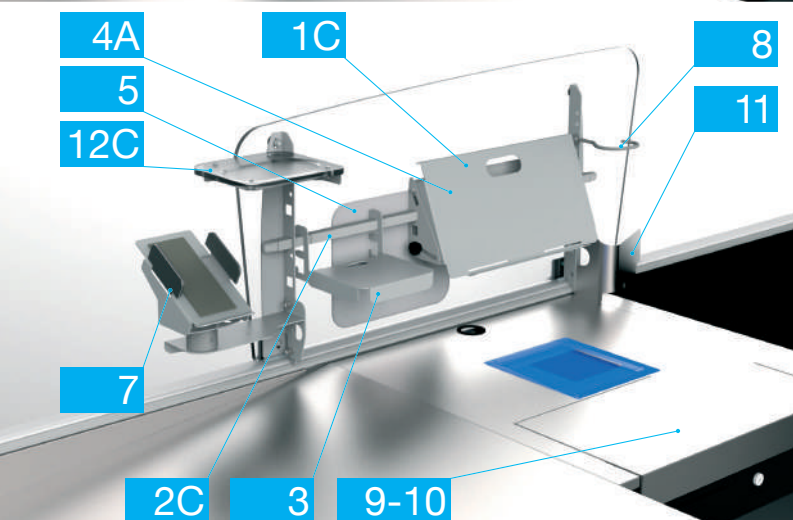
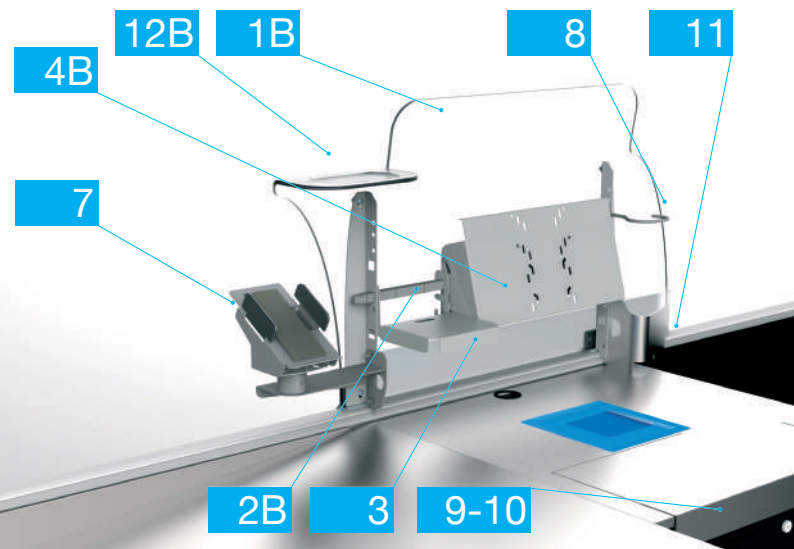
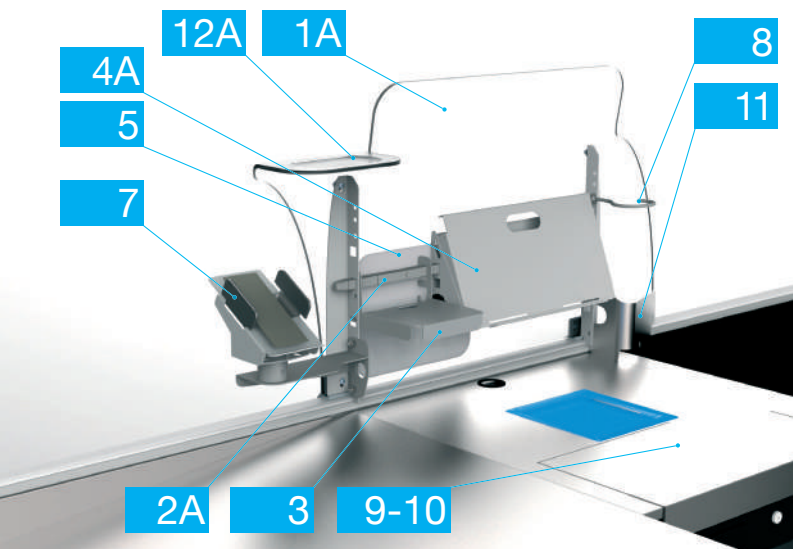

Funzionalità mobile cassa

Function enhancement accessories

- 20A. Prese Ausiliarie 2 SCHUKO - Auxiliary socket 2 SCHUKO
- 20B. Prese Ausiliarie 4 SCHUKO - Auxiliary socket 4 SCHUKO
- 21. Canale portacavi-portaprese aggiuntivo
Additional socket and cable support
- 22. Raccoglibriciole con spazzola
Crumb collector with brush
- 23A. Piano CPU-servizio fisso anteriore
Front CPU-service fixed shelf
- 23B. Piano CPU-servizio fisso posteriore
Rear CPU-service fixed shelf
- 24A. Piano CPU-servizio scorrevole anteriore
Front CPU-service sliding shelf
- 24B. Piano CPU-servizio scorrevole posteriore
Rear CPU-service sliding shelf
- 25. Fissaggio a pavimento
Fastening to the ground assembly
- 26. Sgabello cassa con schienale EN 1335 con seduta regolabile da 42 a 54 cm rispetto al pavimento
Check out stool with back EN 1335 with adjustable sitting from 42 to 54 cm from the floor
- 27. Pedana regolabile + Alloggiamento pedali
Adjustable footboard with pedal housing
- 28. Cassetto servizio sottovasca - Under basin drawer
- 29. Cassetto servizio sottopiano - Under shelf drawer
- 34. Base interna pavimento gamba
Internal base leg
- 35. Copertura longitudinale a pavimento
Longitudinal coverage up to the floor

ACCESSORI

ACCESSORIES

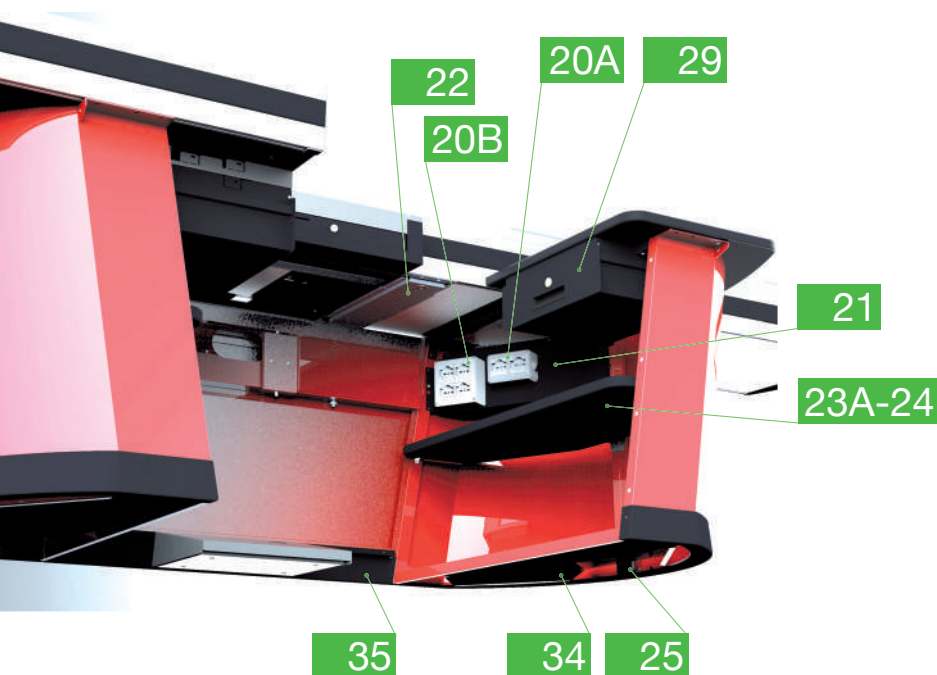

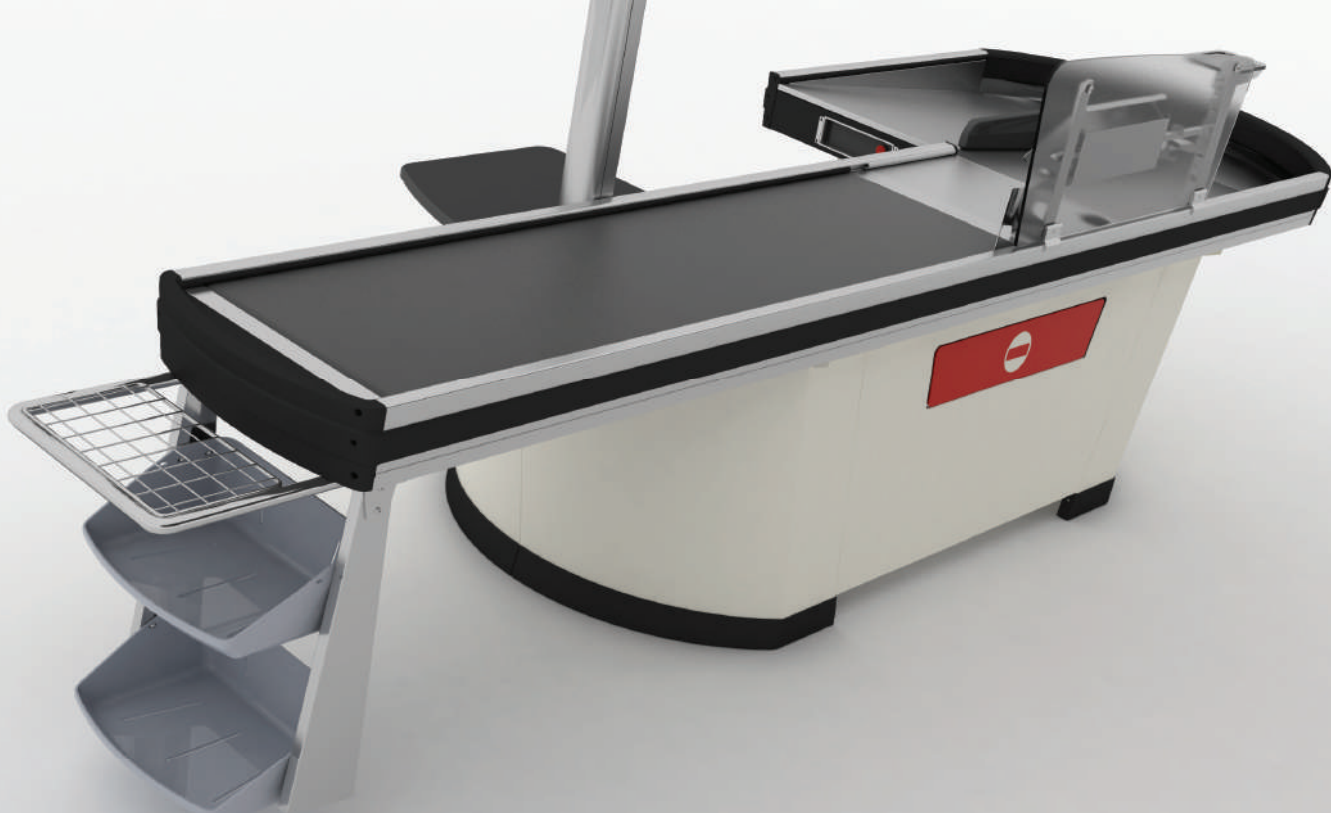

MODELLO

MODEL

NSV - NSV BtB

Codice Code	Modello Model	L (mm)	N (mm)	S (mm)	V (mm)	A (mm)	B (mm)	C (mm)	D (mm)	E (mm)	F (mm)	H (mm)
91007004	NSV 225	2250	1150	350	750	790	600	110	1150	575	575	870
91007008	NSV 245	2450	1350	350	750	790	600	310	1150	575	575	870
91007016	NSV 265	2650	1350	350	950	790	600	310	1150	575	575	870
91007020	NSV 285	2850	1550	350	950	790	600	510	1150	575	575	870
91007024	NSV 305	3050	1750	350	950	790	600	710	1150	575	575	870
91007036	NSV 325	3250	1750	350	1150	790	600	710	1150	575	575	870
91007040	NSV 345	3450	1950	350	1150	790	600	910	1150	575	575	870
91007052	NSV 365	3650	1950	350	1350	790	600	910	1150	575	575	870
91007056	NSV 385	3850	2150	350	1350	790	600	1110	1150	575	575	870
91007060	NSV 405	4050	2350	350	1350	790	600	1310	1150	575	575	870

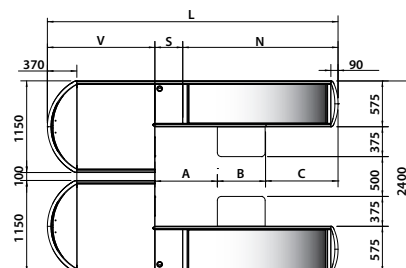
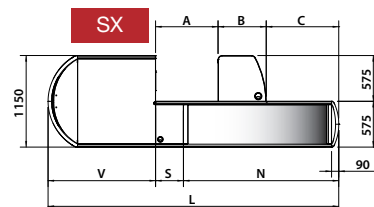
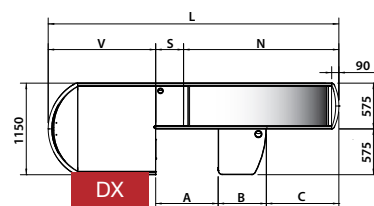
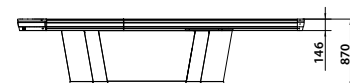

ACCESSORI

ACCESSORIES

1A		20A	
1B		20B	
1C		21	
1D		22	
2A		23A	
2B		23B	
2C		24A	
2D		24B	
3		25	
4A		26	
4B		27	
4C		28	
5		29	
6		34	
7		35	
8			
9			
10			
11			
12A			
12B			
12C			
12D			

40A	
40B	
41A	
41B	
41C	
41D	
41E	
41F 75	
41F 150	
42	
43A	
43B	
43C	
43D	
44	
45	da 265 a 405
46	
47	da 265 a 405
48A	da 305 a 405
48B	da 305 a 405
48C	da 345 a 405
48D	da 235 a 405
49A	da 235 a 405
49B	da 235 a 405
50	da 245 a 405
51A	da 245 a 405
51B	da 245 a 405
52	da 245 a 405
53	



MODELLO

MODEL

NSCV - NSCV BtB

Codice Code	Modello Model	L (mm)	N (mm)	S (mm)	V (mm)	A (mm)	B (mm)	C (mm)	D (mm)	E (mm)	F (mm)	H (mm)
91007104	NSCV 225	2250	950	550	750	790	600	110	1150	575	575	870
91007108	NSCV 245	2450	1150	550	750	790	600	310	1150	575	575	870
91007116	NSCV 265	2650	1150	550	950	790	600	310	1150	575	575	870
91007120	NSCV 285	2850	1350	550	950	790	600	510	1150	575	575	870
91007124	NSCV 305	3050	1550	550	950	790	600	710	1150	575	575	870
91007136	NSCV 325	3250	1550	550	1150	790	600	710	1150	575	575	870
91007140	NSCV 345	3450	1750	550	1150	790	600	910	1150	575	575	870
91007152	NSCV 365	3650	1750	550	1350	790	600	910	1150	575	575	870
91007156	NSCV 385	3850	1950	550	1350	790	600	1110	1150	575	575	870
91007160	NSCV 405	4050	2150	550	1350	790	600	1310	1150	575	575	870
91007164	NSCV 425	4250	2350	550	1350	790	600	1510	1150	575	575	870

15

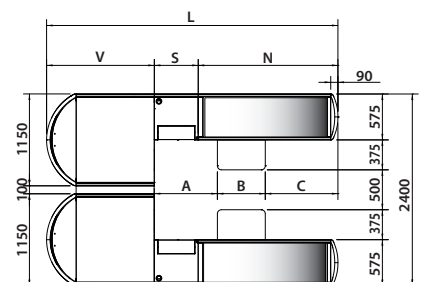
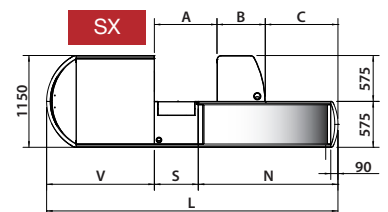
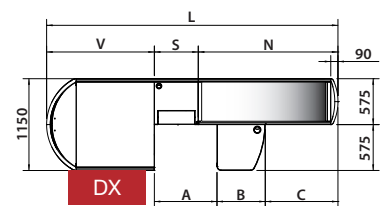
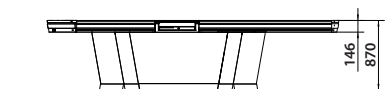

ACCESSORI

ACCESSORIES

1A	20A
1B	20B
1C	21
1D	22
2A	23A
2B	23B
2C	24A
2D	24B
3	25
4A	26
4B	27
4C	28
5	29
6	34
7	35
8	
9	
10	
11	
12A	
12B	
12C	
12D	

40A	
40B	
41A	
41B	
41C	
41D	
41E	
41F 75	
41F 150	
42	
43A	
43B	
43C	
43D	
44	
45	da 265 a 425
46	
47	da 245 a 425
48A	da 305 a 425
48B	da 305 a 425
48C	da 345 a 425
48D	da 285 a 425
49A	da 235 a 405
49B	da 235 a 405
50	
51A	
51B	
52	da 245 a 425
53	

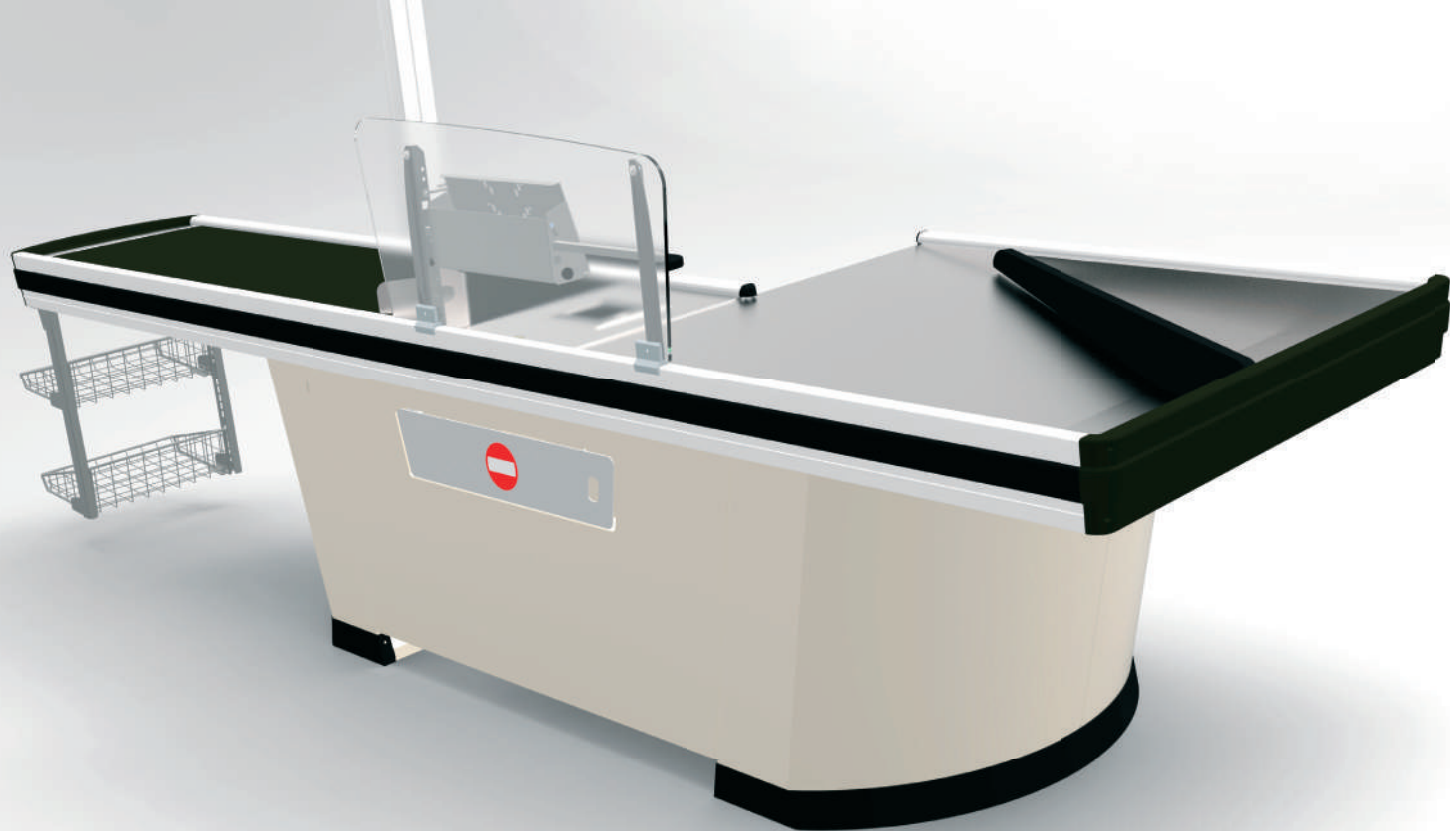

MODELLO

MODEL

NSV DIVA/H

16

Codice Code	Modello Model	L (mm)	N (mm)	S (mm)	V (mm)	A (mm)	B (mm)	C (mm)	D (mm)	E (mm)	F (mm)	H (mm)
91010004	NSV H 213	2125	1150	350	625	790	600	110	1150	575	575	870
91010008	NSV H 233	2325	1350	350	625	790	600	310	1150	575	575	870
91010016	NSV H 253	2525	1350	350	825	790	600	310	1150	575	575	870
91010020	NSV H 273	2725	1550	350	825	790	600	510	1150	575	575	870
91010024	NSV H 293	2925	1750	350	825	790	600	710	1150	575	575	870
91010036	NSV H 313	3125	1750	350	1025	790	600	710	1150	575	575	870
91010040	NSV H 333	3325	1950	350	1025	790	600	910	1150	575	575	870
91010052	NSV H 353	3525	1950	350	1225	790	600	910	1150	575	575	870
91010056	NSV H 373	3725	2150	350	1225	790	600	1110	1150	575	575	870
91010060	NSV H 393	3925	2350	350	1225	790	600	1310	1150	575	575	870

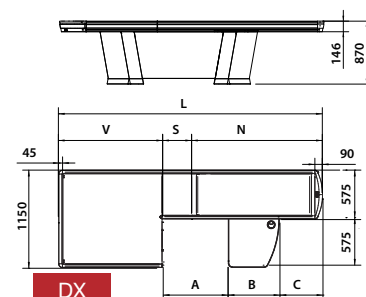

DX

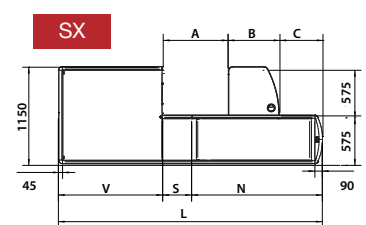

SX

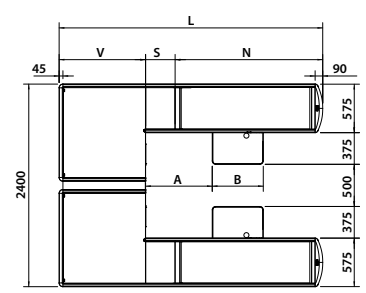

BtB

ACCESSORI

ACCESSORIES

1A		20A	
1B		20B	
1C		21	
1D		22	
2A		23A	
2B		23B	
2C		24A	
2D		24B	
3		25	
4A		26	
4B		27	
4C		28	
5		29	
6		34	
7		35	
8			
9			
10			
11			
12A			
12B			
12C			
12D			

40A	
40B	
41A	
41B	
41C	
41D	
41E	
41F 75	
41F 150	
42	
43A	
43B	
43C	
43D	
44	
45	da 353 a 393
46	
47	
48A	da 293 a 393
48B	da 293 a 393
48C	da 333 a 393
48D	da 273 a 393
49A	da 273 a 393
49B	da 273 a 393
50	
51A	
51B	
52	da 233 a 393
53	

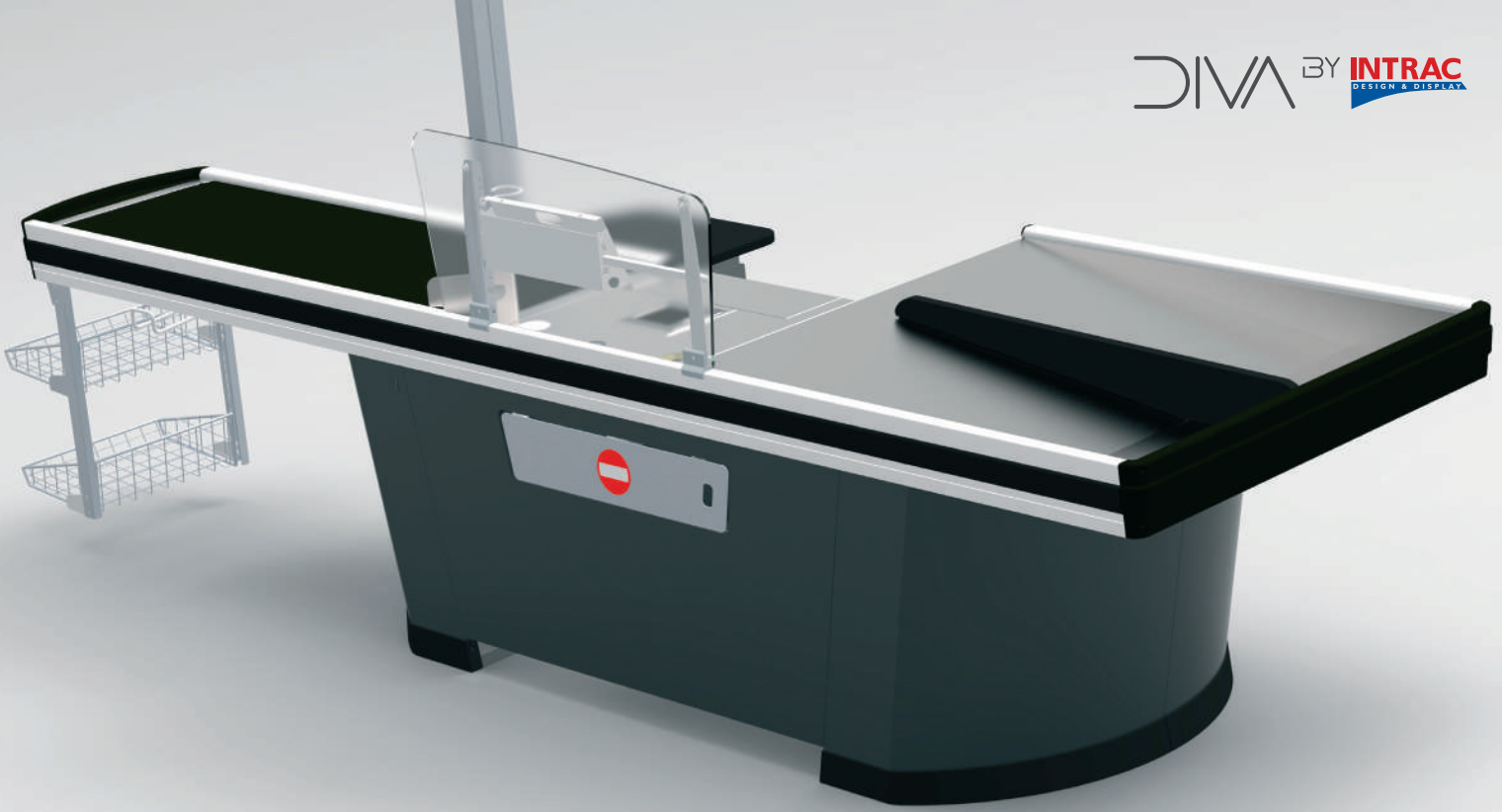

MODELLO

MODEL

NSCV DIVA/H

Codice Code	Modello Model	L (mm)	N (mm)	S (mm)	V (mm)	A (mm)	B (mm)	C (mm)	D (mm)	E (mm)	F (mm)	H (mm)
91010104	NSCV H 213	2125	950	550	625	790	600	110	1150	575	575	870
91010108	NSCV H 233	2325	1150	550	625	790	600	310	1150	575	575	870
91010116	NSCV H 253	2525	1150	550	825	790	600	310	1150	575	575	870
91010120	NSCV H 273	2725	1350	550	825	790	600	510	1150	575	575	870
91010124	NSCV H 293	2925	1550	550	825	790	600	710	1150	575	575	870
91010136	NSCV H 313	3125	1550	550	1025	790	600	710	1150	575	575	870
91010140	NSCV H 333	3325	1750	550	1025	790	600	910	1150	575	575	870
91010152	NSCV H 353	3525	1750	550	1225	790	600	910	1150	575	575	870
91010156	NSCV H 373	3725	1950	550	1225	790	600	1110	1150	575	575	870
91010160	NSCV H 393	3925	2150	550	1225	790	600	1310	1150	575	575	870
91010164	NSCV H 413	4125	2325	550	1225	790	600	1510	1150	575	575	870

ACCESSORI

ACCESSORIES

1A		20A	
1B		20B	
1C		21	
1D		22	
2A		23A	
2B		23B	
2C		24A	
2D		24B	
3		25	
4A		26	
4B		27	
4C		28	
5		29	
6		34	
7		35	
8			
9			
10			
11			
12A			
12B			
12C			
12D			

40A	
40B	
41A	
41B	
41C	
41D	
41E	
41F 75	
41F 150	
42	
43A	
43B	
43C	
43D	
44	
45	da 353 a 413
46	
47	
48A	da 293 a 413
48B	da 293 a 413
48C	da 333 a 413
48D	da 273 a 413
49A	da 273 a 413
49B	da 273 a 413
50	
51A	
51B	
52	da 233 a 413
53	

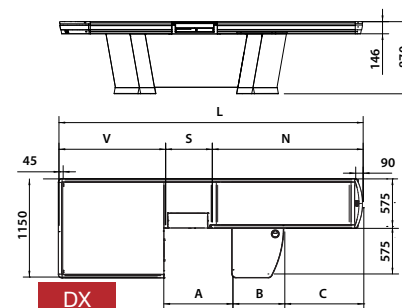

DX

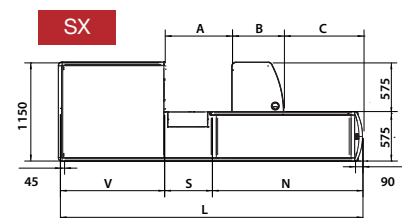

SX

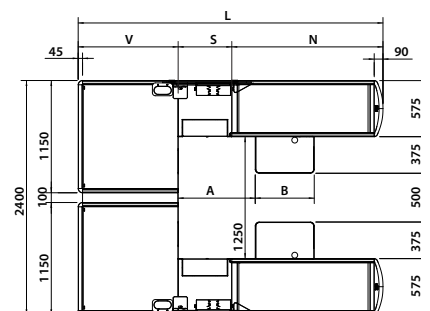

BtB



MODELLO

MODEL

NSVD

18

Codice Code	Modello Model	L (mm)	N (mm)	S (mm)	V (mm)	A (mm)	B (mm)	C (mm)	D (mm)	E (mm)	F (mm)	H (mm)
91007504	NSVD 225	2250	1150	350	750		600	300	1150	575	575	870
91007506	NSVD 245	2450	1350	350	750		600	410	1150	575	575	870
91007510	NSVD 265	2650	1350	350	950		600	310	1150	575	575	870
91007512	NSVD 285	2850	1550	350	950		600	510	1150	575	575	870
91007514	NSVD 305	3050	1750	350	950		600	710	1150	575	575	870
91007520	NSVD 325	3250	1750	350	1150		600	710	1150	575	575	870
91007522	NSVD 345	3450	1950	350	1150		600	910	1150	575	575	870

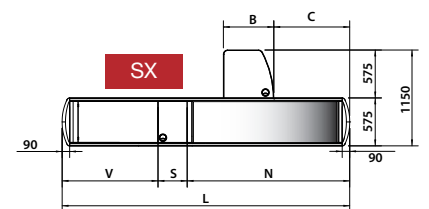
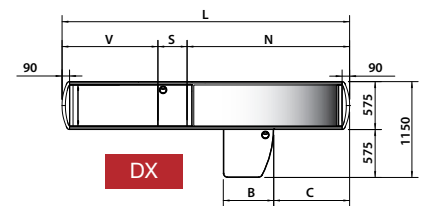

ACCESSORI

ACCESSORIES

1A		20A	
1B		20B	
1C		21	
1D		22	
2A		23A	
2B		23B	
2C		24A	
2D		24B	
3		25	
4A		26	
4B		27	
4C		28	
5		29	
6		34	
7		35	
8			
9			
10			
11			
12A			
12B			
12C			
12D			

40A	
40B	
41A	
41B	
41C	
41D	
41E	
41F 75	
41F 150	
42	
43A	
43B	
43C	
43D	
44	
45	225
46	da 225 a 345
47	da 225 a 345
48A	da 285 a 345
48B	da 285 a 345
48C	345
48D	da 245 a 345
49A	da 245 a 345
49B	da 245 a 345
50	
51A	
51B	
52	
53	

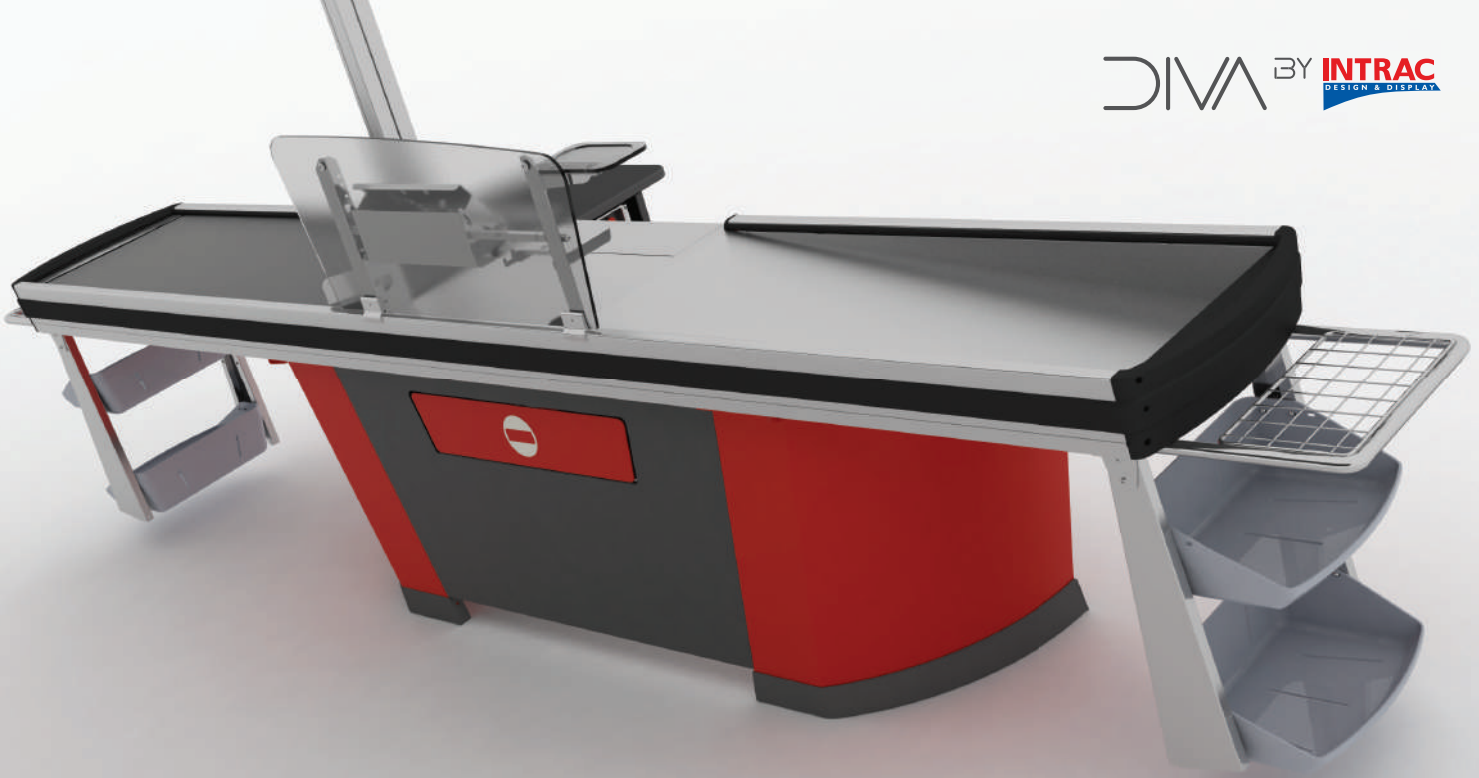

MODELLO

MODEL

NSCVD

Codice Code	Modello Model	L (mm)	N (mm)	S (mm)	V (mm)	A (mm)	B (mm)	C (mm)	D (mm)	E (mm)	F (mm)	H (mm)
91007554	NSCVD 225	2250	950	550	750		600	110	1150	575	575	870
91007556	NSCVD 245	2450	1150	550	750		600	300	1150	575	575	870
91007560	NSCVD 265	2650	1150	550	950		600	310	1150	575	575	870
91007562	NSCVD 285	2850	1350	550	950		600	510	1150	575	575	870
91007564	NSCVD 305	3050	1550	550	950		600	710	1150	575	575	870
91007570	NSCVD 325	3250	1550	550	1150		600	710	1150	575	575	870
91007572	NSCVD 345	3450	1750	550	1150		600	910	1150	575	575	870
91007574	NSCVD 365	3650	1750	550	1350		600	910	1150	575	575	870
91007576	NSCVD 385	3850	1950	550	1350		600	1110	1150	575	575	870
91007578	NSCVD 405	4050	2150	550	1350		600	1310	1150	575	575	870
91007580	NSCVD 425	4250	2350	550	1350		600	1510	1150	575	575	870

19

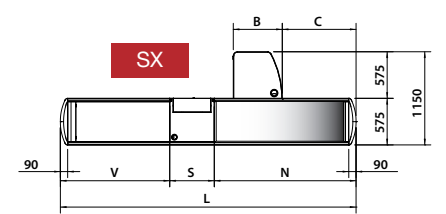
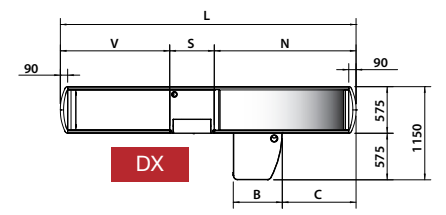
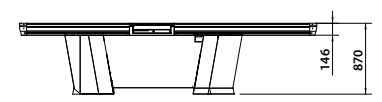

ACCESSORI

ACCESSORIES

1A		20A	
1B		20B	
1C		21	
1D		22	
2A		23A	
2B		23B	
2C		24A	
2D		24B	
3		25	
4A		26	
4B		27	
4C		28	
5		29	
6		34	
7		35	
8			
9			
10			
11			
12A			
12B			
12C			
12D			

40A	
40B	
41A	
41B	
41C	
41D	
41E	
41F 75	
41F 150	
42	
43A	
43B	
43C	
43D	
44	
45	da 285 a 425
46	
47	
48A	da 305 a 425
48B	da 305 a 425
48C	da 345 a 425
48D	
49A	da 265 a 425
49B	da 265 a 425
50	
51A	
51B	
52	
53	



MODELLO

MODEL

TWIN CS

20

Codice Code	Modello Model	L (mm)	N (mm)	S (mm)	V (mm)	A (mm)	B (mm)	C (mm)	D (mm)	E (mm)	F (mm)	H (mm)
91007810	TWIN CS 325R	3250	1550	550	1150	790	600	1350	1175	575	375	870
91007811	TWIN CS 325L											
91007816	TWIN CS 345R	3450	1550	550	1350	790	600	400	1175	575	375	870
91007817	TWIN CS 345L											
91007822	TWIN CS 365R	3650	1750	550	1350	790	600	800	1175	575	375	870
91007823	TWIN CS 365L											
91007828	TWIN CS 385R	3850	1950	550	1350	790	600	1100	1175	575	375	870
91007829	TWIN CS 385L											

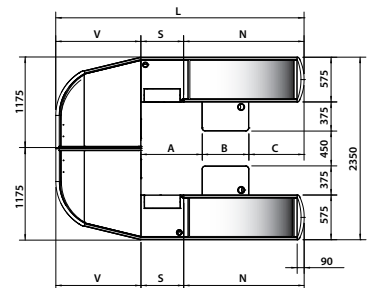
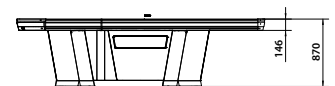

ACCESSORI

ACCESSORIES

1A
1B
1C
1D
2A
2B
2C
2D
3
4A
4B
4C
5
6
7
8
9
10
11
12A
12B
12C
12D

20A
20B
21
22
23A
23B
24A
24B
25
26
27
28
29
34
35

40A
40B
41A
41B
41C
41D
41E
41F 75
41F 150
42
43A
43B
43C
43D
44
45
46
47
48A
48B
48C
48D
49A
49B
50
51A
51B
52
53

da 365 a 385



MODELLO

MODEL

TWIN C

Codice Code	Modello Model	L (mm)	N (mm)	S (mm)	V (mm)	A (mm)	B (mm)	C (mm)	D (mm)	E (mm)	F (mm)	H (mm)
91007760	TWIN C 345R	3450	1350	550	1550	790	600	510	1175	575	375	870
91007761	TWIN C 345L	3450	1350	550	1550	790	600	510	1175	575	375	870
91007766	TWIN C 365R	3650	1550	550	1550	790	600	710	1175	575	375	870
91007767	TWIN C 365L	3650	1550	550	1550	790	600	710	1175	575	375	870
91007772	TWIN C 385R	3850	1750	550	1550	790	600	910	1175	575	375	870
91007773	TWIN C 385L	3850	1750	550	1550	790	600	910	1175	575	375	870
91007778	TWIN C 405R	4050	1950	550	1550	790	600	1110	1175	575	375	870
91007779	TWIN C 405L	4050	1950	550	1550	790	600	1110	1175	575	375	870
91007784	TWIN C 425R	4250	2150	550	1550	790	600	1110	1175	575	375	870
91007785	TWIN C 425L	4250	2150	550	1550	790	600	1110	1175	575	375	870

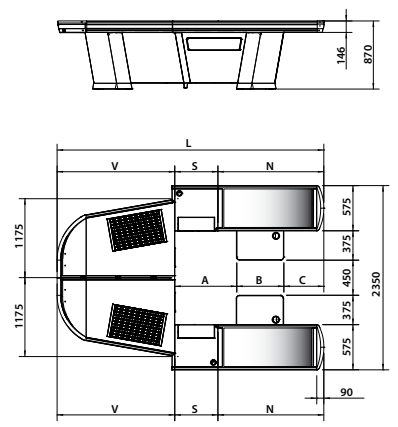

ACCESSORI

ACCESSORIES

1A
1B
1C
1D
2A
2B
2C
2D
3
4A
4B
4C
5
6
7
8
9
10
11
12A
12B
12C
12D

20A
20B
21
22
23A
23B
24A
24B
25
26
27
28
29
34
35

40A
40B
41A
41B
41C
41D
41E
41F 75
41F 150
42
43A
43B
43C
43D
44
45
46
47
48A
48B
48C
48D
49A
49B
50
51A
51B
52
53

da 365 a 425
da 365 a 425
da 385 a 425



MODELLO

MODEL

TWIN F1

22

Codice Code	Modello Model	L (mm)	N (mm)	S (mm)	V (mm)	A (mm)	B (mm)	C (mm)	D (mm)	E (mm)	F (mm)	H (mm)
91007910	TWIN F1 325R	3250	1550	550	1150	790	600	710	1000	575	650	870
91007911	TWIN F1 325L	3250	1550	550	1150	790	600	710	1000	575	650	870
91007916	TWIN F1 345R	3450	1750	550	1150	790	600	910	1000	575	650	870
91007917	TWIN F1 345L	3450	1750	550	1150	790	600	910	1000	575	650	870
91007922	TWIN F1 365R	3650	1750	550	1350	790	600	910	1000	575	650	870
91007923	TWIN F1 365L	3650	1750	550	1350	790	600	910	1000	575	650	870
91007928	TWIN F1 385R	3850	1950	550	1350	790	600	1110	1000	575	650	870
91007929	TWIN F1 385L	3850	1950	550	1350	790	600	1110	1000	575	650	870
91007934	TWIN F1 405R	4050	2150	550	1350	790	600	1310	1000	575	650	870
91007935	TWIN F1 405L	4050	2150	550	1350	790	600	1310	1000	575	650	870

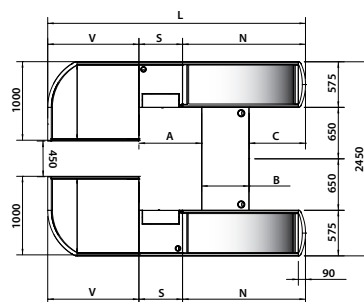

ACCESSORI

ACCESSORIES

1A
1B
1C
1D
2A
2B
2C
2D
3
4A
4B
4C
5
6
7
8
9
10
11
12A
12B
12C
12D

20A
20B
21
22
23A
23B
24A
24B
25
26
27
28
29
34
35

40A
40B
41A
41B
41C
41D
41E
41F 75
41F 150
42
43A
43B
43C
43D
44
45
46
47
48A
48B
48C
48D
49A
49B
50
51A
51B
52
53

da 345 a 405

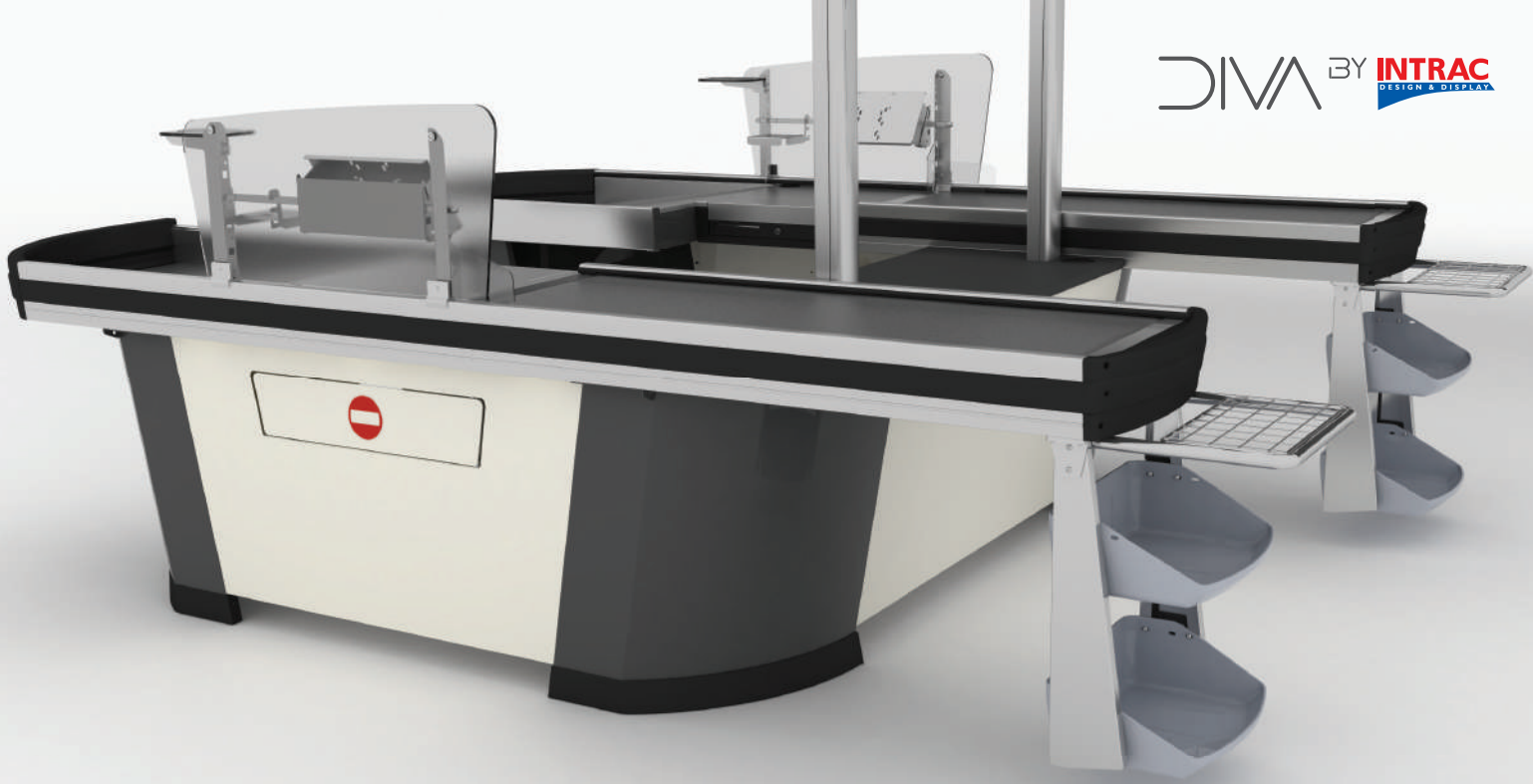

MODELLO

MODEL

TWIN F2

Codice Code	Modello Model	L (mm)	N (mm)	S (mm)	V (mm)	A (mm)	B (mm)	C (mm)	D (mm)	E (mm)	F (mm)	H (mm)
91007960	TWIN F2 325R	3250	1550	550	1150	790	600	710	800	575	650	870
91007961	TWIN F2 325L	3250	1550	550	1150	790	600	710	800	575	650	870
91007966	TWIN F2 345R	3450	1750	550	1150	790	600	910	800	575	650	870
91007967	TWIN F2 345L	3450	1750	550	1150	790	600	910	800	575	650	870
91007972	TWIN F2 365R	3650	1750	550	1350	790	600	910	800	575	650	870
91007973	TWIN F2 365L	3650	1750	550	1350	790	600	910	800	575	650	870
91007978	TWIN F2 385R	3850	1950	550	1350	790	600	1110	800	575	650	870
91007979	TWIN F2 385L	3850	1950	550	1350	790	600	1110	800	575	650	870
91007984	TWIN F2 405R	4050	2150	550	1350	790	600	1310	800	575	650	870
91007985	TWIN F2 405L	4050	2150	550	1350	790	600	1310	800	575	650	870

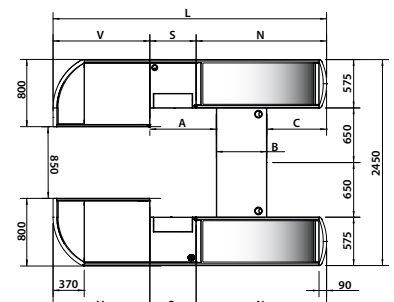

ACCESSORI

ACCESSORIES

1A
1B
1C
1D
2A
2B
2C
2D
3
4A
4B
4C
5
6
7
8
9
10
11
12A
12B
12C
12D

20A
20B
21
22
23A
23B
24A
24B
25
26
27
28
29
34
35

40A
40B
41A
41B
41C
41D
41E
41F 75
41F 150
42
43A
43B
43C
43D
44
45
46
47
48A
48B
48C
48D
49A
49B
50
51A
51B
52
53

da 345 a 405

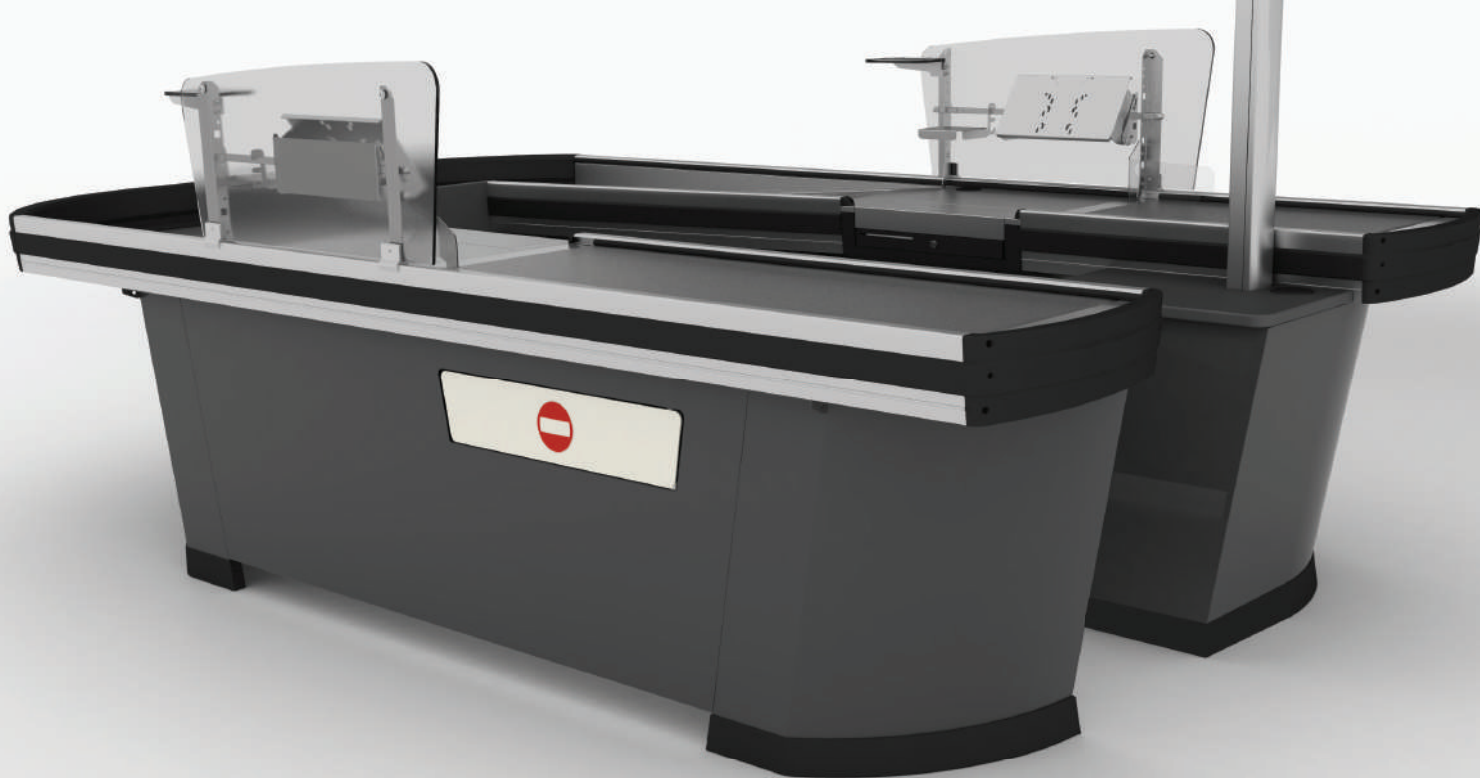

MODELLO

MODEL

TWIN B

24

Codice Code	Modello Model	L (mm)	N (mm)	S (mm)	V (mm)	A (mm)	B (mm)	C (mm)	D (mm)	E (mm)	F (mm)	H (mm)
91007710	TWIN B 345R	3450	950	550	1950	790	600	110	1000	575	375	870
R DX L SX	TWIN B 345L	3450	1550	550	1350	1150	600	110	1000	575	0	870
91007716	TWIN B 365R	3650	1150	550	1950	790	600	310	1000	575	375	870
R DX L SX	TWIN B 365L	3650	1750	550	1350	1150	600	310	1000	575	0	870
91007722	TWIN B 385R	3850	1350	550	1950	790	600	510	1000	575	375	870
R DX L SX	TWIN B 385L	3850	1950	550	1350	1150	600	510	1000	575	0	870
91007728	TWIN B 405R	4050	1550	550	1950	790	600	710	1000	575	375	870
R DX L SX	TWIN B 405L	4050	2150	550	1350	1150	600	710	1000	575	0	870
91007734	TWIN B 425R	4250	1750	550	1950	790	600	910	1000	575	375	870
R DX L SX	TWIN B 425L	4250	2350	550	1350	1150	600	910	1000	575	0	870

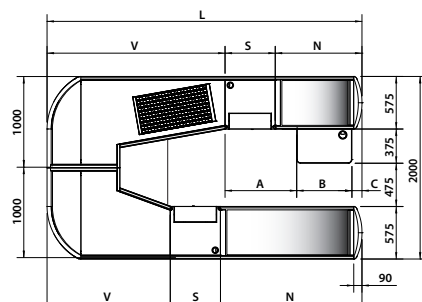
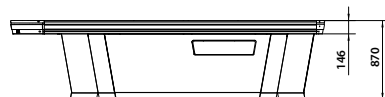

ACCESSORI

ACCESSORIES

1A
1B
1C
1D
2A
2B
2C
2D
3
4A
4B
4C
5
6
7
8
9
10
11
12A
12B
12C
12D

20A
20B
21
22
23A
23B
24A
24B
25
26
27
28
29
34
35

40A
40B
41A
41B
41C
41D
41E
41F 75
41F 150
42
43A
43B
43C
43D
44
45
46
47
48A
48B
48C
48D
49A
49B
50
51A
51B
52
53

L (R?)

da 405 a 425

da 405 a 425

425

da 385 a 425

da 385 a 425

da 385 a 425

da 365 a 425

da 365 a 425

da 365 a 425

da 365 a 425

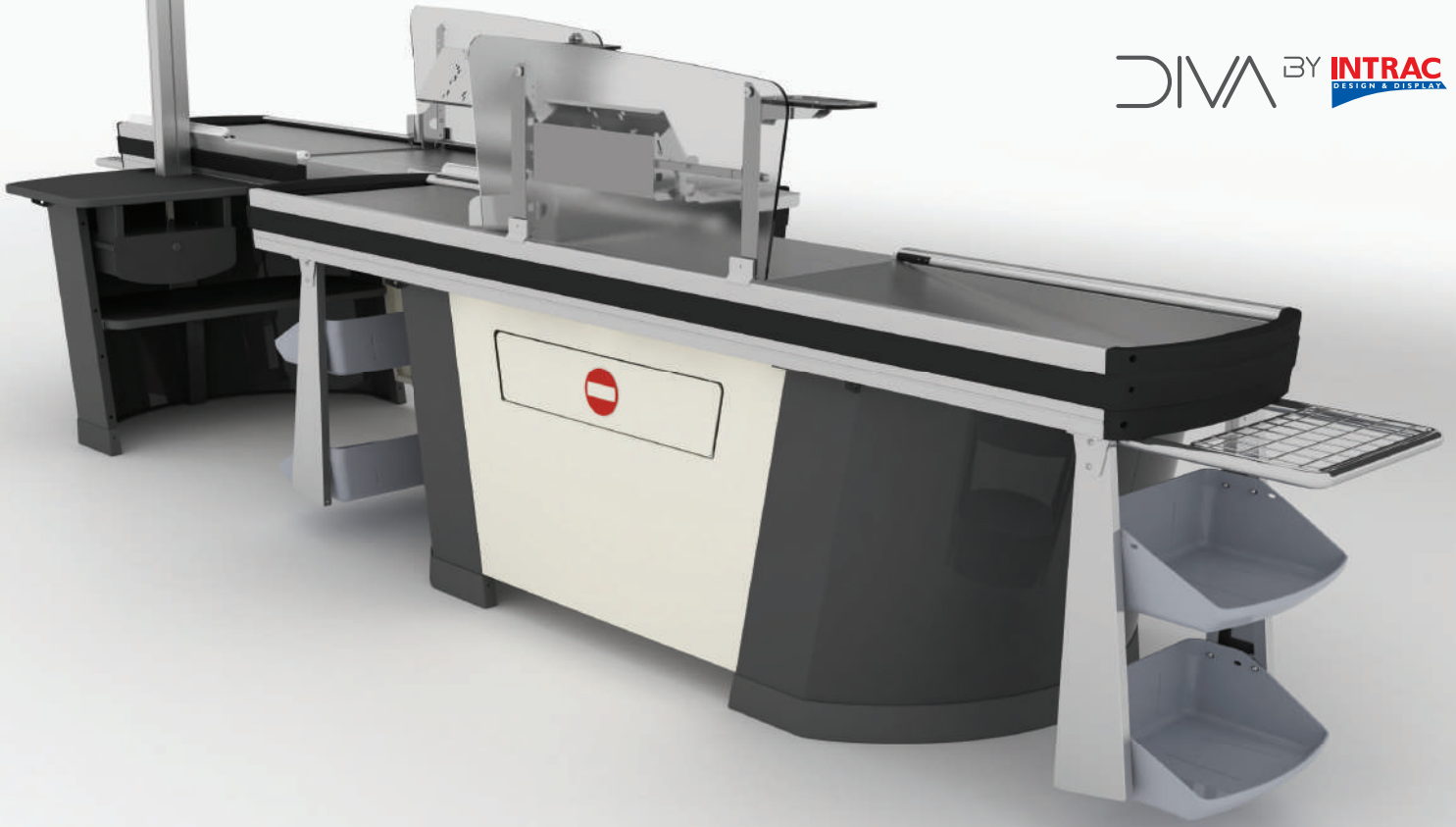

MODELLO

MODEL

TANDEM

Codice Code	Modello Model	L (mm)	N (mm)	S (mm)	V (mm)	A (mm)	B (mm)	C (mm)	D (mm)	E (mm)	F (mm)	H (mm)
91007600	TANDEM 380R	2250	950	550	750	830	600	120	575	575	575	870
R DX L SX	TANDEM 380L	2250	950	550	750	810	600	140	575	575	575	870
91007604	TANDEM 400R	2450	950	550	950	790	600	160	575	575	575	870
R DX L SX	TANDEM 400L	2450	950	550	950	790	600	160	575	575	575	870
91007608	TANDEM 440R	2650	1150	550	950	820	600	330	575	575	575	870
R DX L SX	TANDEM 440L	2650	1150	550	950	820	600	330	575	575	575	870
91007612	TANDEM 460R	2850	1150	550	1150	840	600	310	575	575	575	870
R DX L SX	TANDEM 460L	2850	1150	550	1150	810	600	340	575	575	575	870
91007620	TANDEM 500R	3050	1350	550	1150	840	600	510	575	575	575	870
R DX L SX	TANDEM 500L	3050	1350	550	1150	1000	600	350	575	575	575	870
91007624	TANDEM 535R	3250	1550	550	1150	810	600	690	575	575	575	870
R DX L SX	TANDEM 535L	3250	1550	550	1150	980	600	520	575	575	575	870

ACCESSORI

ACCESSORIES

1A	20A
1B	20B
1C	21
1D	22
2A	23A
2B	23B
2C	24A
2D	24B
3	25
4A	26
4B	27
4C	28
5	29
6	34
7	35
8	
9	
10	
11	
12A	
12B	
12C	
12D	

40A	DXR/SXL
40B	DXR/SXL
41A	
41B	
41C	
41D	
41E	
41F 75	
41F 150	
42	
43A	
43B	
43C	
43D	
44	
45	
46	
47	
48A	
48B	
48C	
48D	
49A	
49B	
50	
51A	
51B	
52	
53	

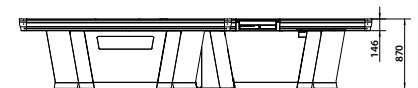

DX

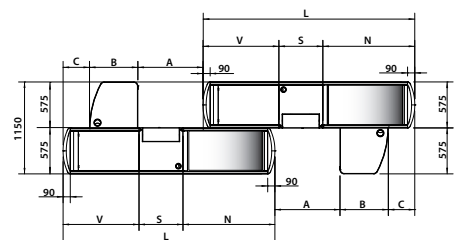

SX

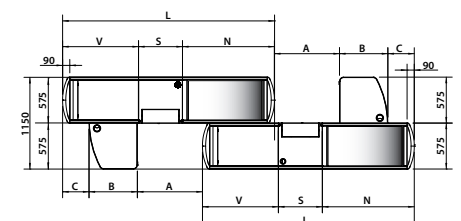



innovazione tecnologica

technologic innovation

Design, funzionalità, prestazione ed affidabilità sono i punti fondamentali che hanno spinto lo staff di Intrac nella realizzazione di questo nuovo banco cassa.

Utilizzare forme e materiali innovativi, uniti ad una struttura portante altamente performante, ci permette di dare vita a progetti per qualsiasi cliente o superficie di vendita.

Design, functionality, performance and reliability are the key points that have pushed Intrac staff in implementing this new project of check-out counters.

Use innovative shapes and materials combined with a high performance structural frame, allows us to develop projects for every customer or department area.

DIVA



DIVA TENDO
INNOVAZIONE MATERICA / NEW MATERIALS

27

DIVA WOOD
L'ALTERNATIVA / THE ALTERNATIVE



avancassa front checkout



FM

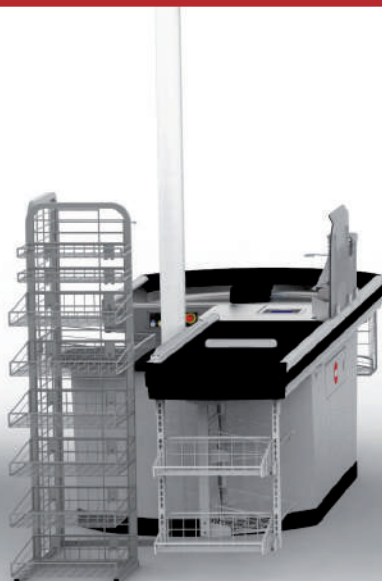

FLF

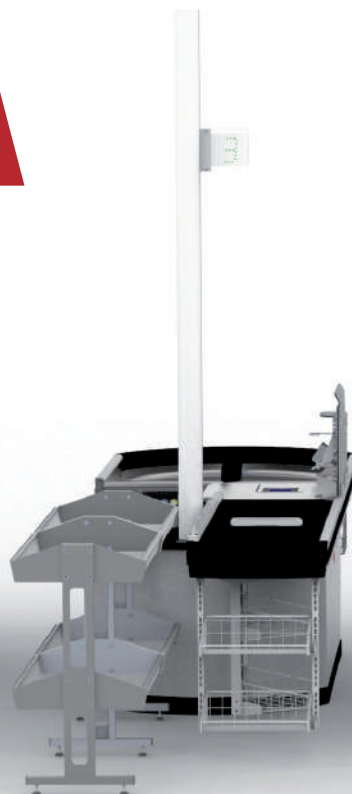

LMD

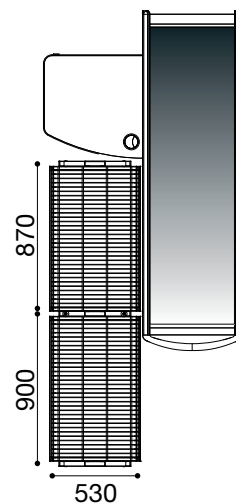
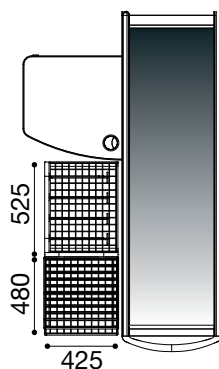
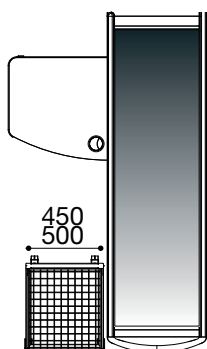
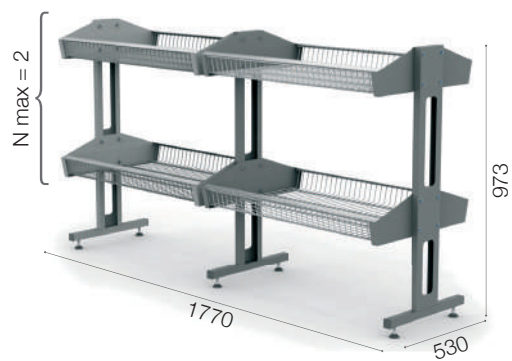
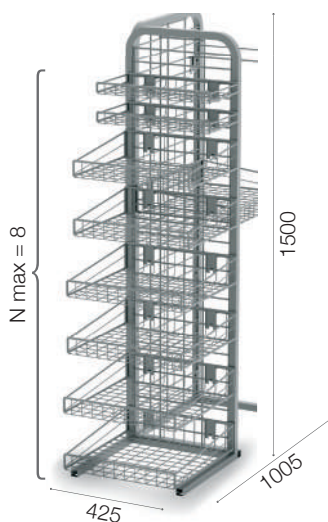
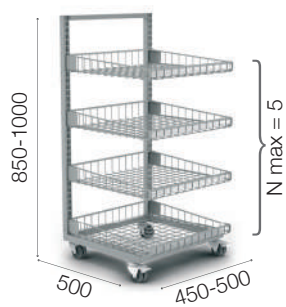



BTB-C



FLM



FLF-C

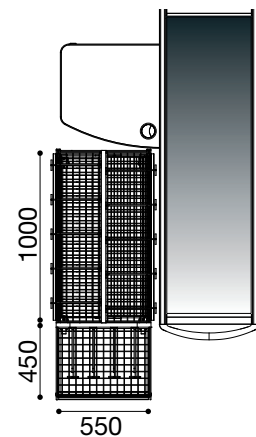
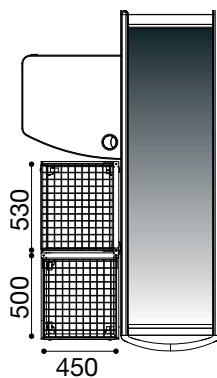
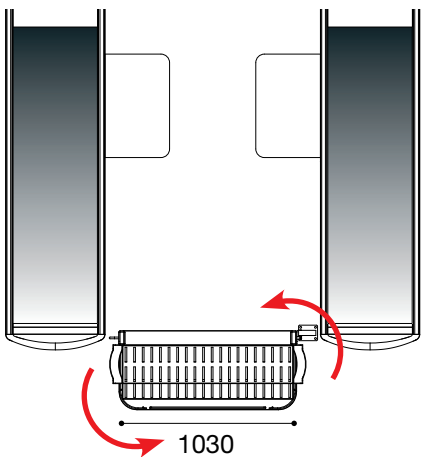
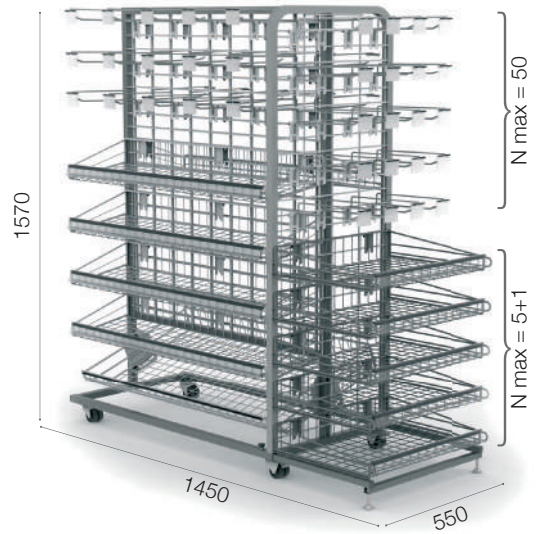
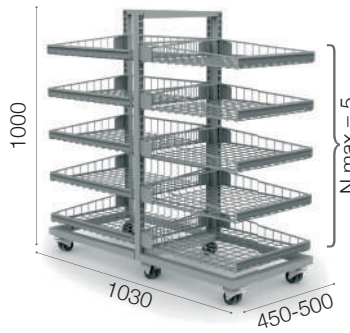
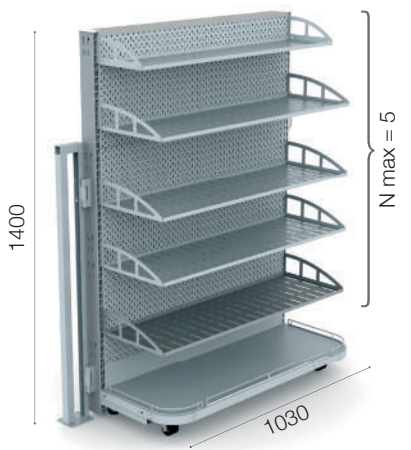

Accessori servizio cliente

Customer service accessories

- 40A. Colonna passacavi 100x70mm - 100x70mm Cable column
- 40B. Colonna passacavi 2xø30mm - 2xø30mm Cable column
- 41A. Lampione numero cassa a BANDIERA
FLAG checkout open/closed lamp
- 41B. Segnalatore numero cassa a DERIVA
DAGGERBOARD checkout open / closed signal
- 41C. Segnalatore numero cassa a FIOCCO
FIOCCO checkout open/closed signal
- 41D. Segnalatore numero cassa OVALE
OVAL checkout open/closed signal
- 41E. Segnalatore numero cassa a VELA
VELA checkout open/closed signal logo
- 41F. Segnalatore numero cassa a 23FLAG H75cm
23FLAG H75cm checkout open/closed signal
- 41F. Segnalatore numero cassa a 23FLAG H150cm
23FLAG H150cm checkout open/closed signal
- 42. Spartimerce in vasca - Grocery divider in the basin

ACCESSORI

ACCESSORIES

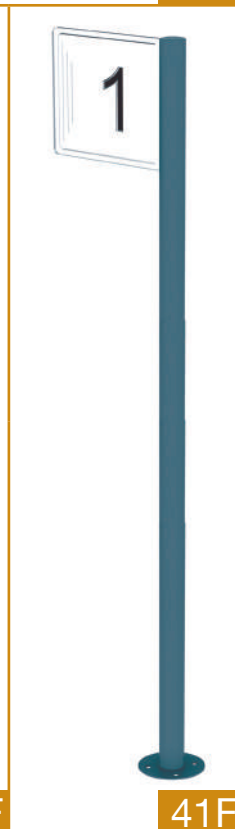
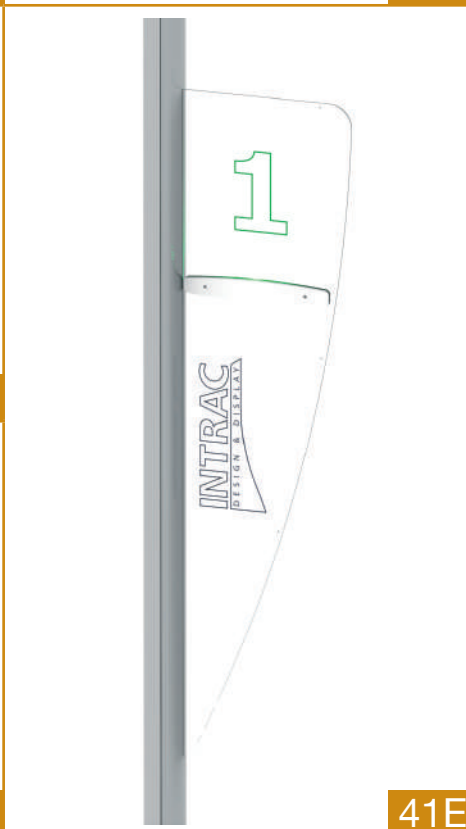

Accessori servizio cliente

Customer service accessories

- 43A.** Chiusura passaggio carrello H20-L60/100
Trolley blocking device H20-L60/100
- 43B.** Chiusura passaggio carrello DIVA L60
Trolley blocking device DIVA L60
- 43C.** Chiusura passaggio carrello DIVA L60/100
Trolley blocking device DIVA L60/100
- 43D.** Chiusura passaggio carrello a nastro
Trolley blocking device ribbon
- 44.** Etichetta uscita di sicurezza - *Emergency exit label*
- 45.** Portasacchetti posteriore 2 vani in filo
Rear 2 level wire bag holder
- 46.** Poggiasacchetti posteriore - *Rear bag rest*
- 47.** Poggia+porta sacchetti posteriore
Rear bag rest+holder
- 48A.** Portasacchetti sospeso anteriore laterale 2 livelli in filo - *2 Level suspended lateral front bag-holder*
- 48B.** Portasacchetti sospeso anteriore laterale 2 livelli ABS - *2 Level suspended lateral front plastic holder*
- 48C.** Portasacchetti anteriore laterale L800 a 3 livelli in filo su ruote
3 Level on wheel lateral front wire bag holder L800
- 48D.** Portasacchetti anteriore laterale L375 a 3 livelli in filo su ruote
3 Level on wheel lateral front wire bag holder L375
- 49A.** Portasacchetti anteriore frontale 2 livelli in filo
2 Level front wire bag holder
- 49B.** Portasacchetti anteriore frontale 2 livelli ABS
2 Level front plastic bag holder
- 50.** Poggiacesti anteriore - *Front basket rest*
- 51A.** Poggia+porta sacchetti anteriore 2 livelli in filo
2 level front wire bag rest+holder
- 51B.** Poggia+porta sacchetti anteriore 2 livelli ABS
2 level front plastic bag rest+holder
- 52.** Gancio portasacchetti anteriore - *Front bag holder hook*
- 53.** Assieme asta cliente successivo - *Next customer assembly*

31

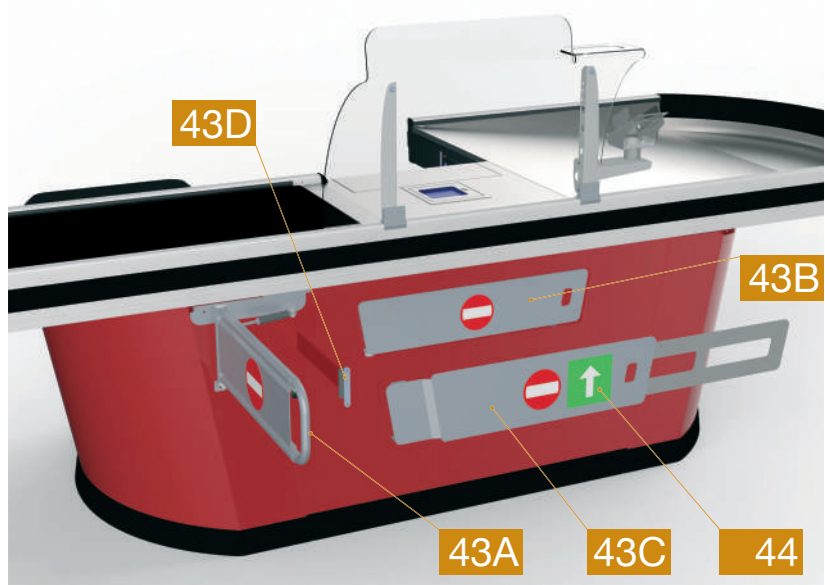

ACCESSORI ACCESSORIES

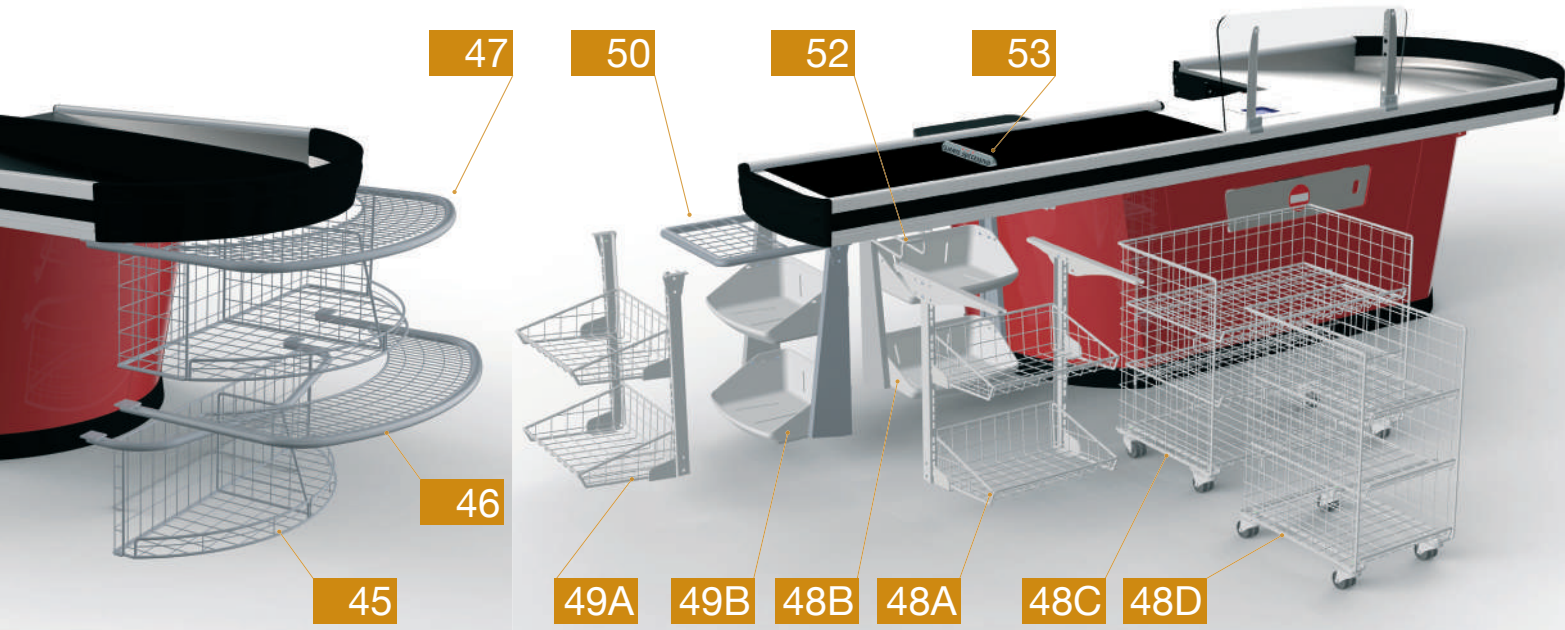

DIVA

l'evoluzione del mobile cassa

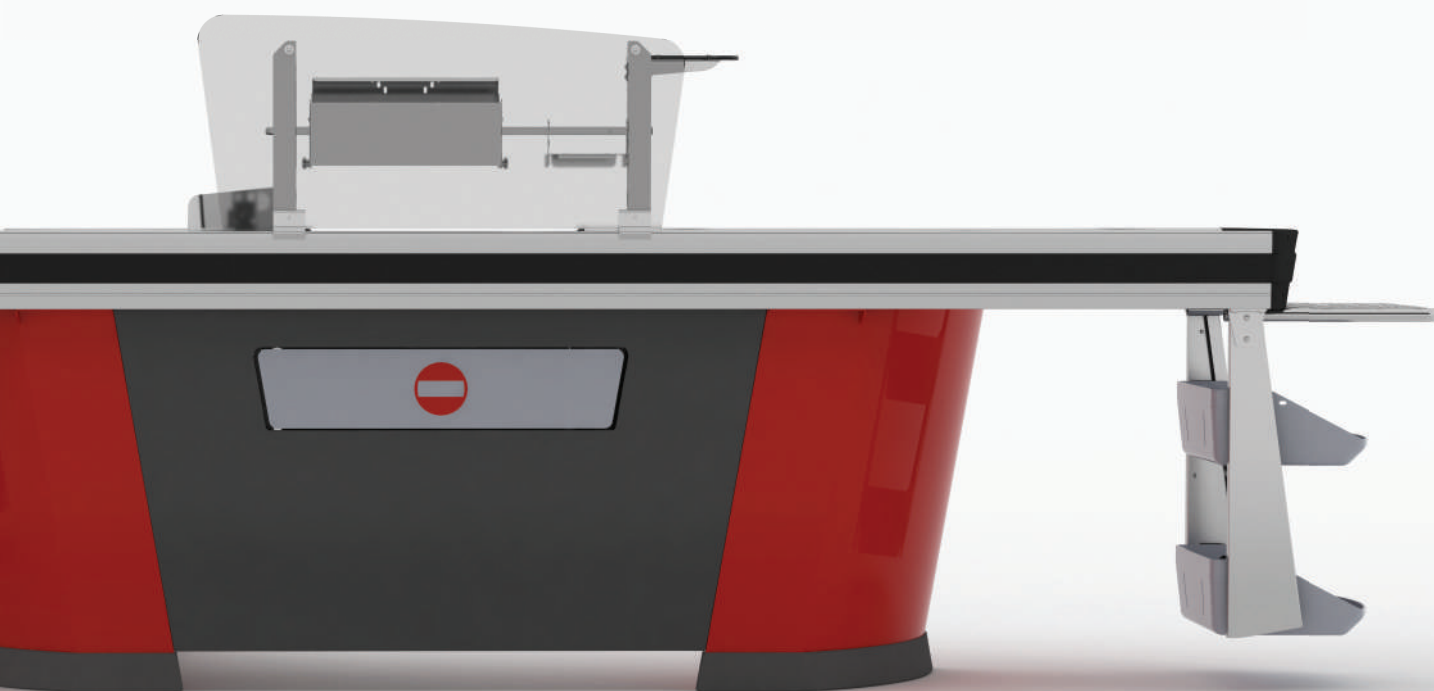

check-out counters
design evolution
concept BY **INTRAC**
DESIGN & DISPLAY

INTRAC[®]
DESIGN & DISPLAY

INTRAC S.p.A. - Via A. Grandi, 24 - 45100 ROVIGO - Italy
Tel. +39 0425 363666 - Fax +39 0425 363600
www.intrac.it - info@intrac.it



L'INTRAC Spa, la cui politica è quella di un continuo perfezionamento, si riserva il diritto di apportare in qualunque momento modifiche ai dati contenuti in questa pubblicazione senza obbligo alcuno di avviso preventivo. • INTRAC Spa, in line with its policy of constant improvement, reserves the right to modify the data included in this catalogue at any time and without notice. • Die Firma INTRAC Spa, deren Politik eine stellige Verbesserung ihrer Produkte ist, behält sich das Recht vor, in irgendeinem Augenblick Inhaltsänderungen, ohne vorherige Benachrichtigungspflicht, in dem vorliegenden Katalog vorzunehmen. • INTRAC Spa, dont la politique est celle d'un perfectionnement continu, se réserve le droit d'apporter des modifications n'importe quand aux données contenues dans ce catalogue, sans aucune obligation de préavis de notre part. • A INTRAC Spa, cuja política de continuo aperfeiçoamento, reserva-se o direito de alterar em qualquer momento, a modificação de dados contidos nesta publicação, sem obrigação alguma de pré aviso. • INTRAC Spa, según su política de continuo refinamiento, se reserva el derecho de modificar los datos incluidos en este catálogo en cualquier momento y sin previo aviso. • Фирма INTRAC SPA, политикой которой является постоянное совершенствование, оставляет за собой право изменить все данные этого каталога в любой момент, без предварительного уведомления.